

Lighting

Contents

Mains 240V Downlights	23 - 24
Fire & Acoustic Rated Downlights	24
Low Voltage Lighting Transformers	25 - 26
Low Voltage Halogen Downlights	26 - 29
Fibre Optic Lighting	29
Low Energy Downlights	30 - 32
Discharge Downlights	32 - 33
Modular	34 - 39
Modular Fluorescent	39 - 40
Weatherproof Battens	41 - 42
Discharge Low Bays & High Bays	43
Fluorescent Battens	44 - 47
Surface Display & Accent Lighting	48 - 51
Striplights & Shaverlights	51 - 52
Wall & Ceiling Lighting	52 - 54
Bulkheads	55 - 61
Exterior Wall Packs	62
Exterior Discharge Floodlights	62 - 64
Urban & Exterior Display Lighting	64 - 66
Halogen Floodlights	67
Lanterns & Bollards	68 - 73
Exterior Display & Link Lighting	74 - 76
Exterior Groundlight Uplighters	76 - 77



Lighting

RECESSED MAINS 240V DOWNLIGHTS



RECESSED LIGHTING: MAINS 240V GU10 HALOGEN DOWNLIGHTS

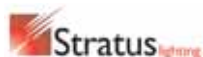

GU10 Mains Voltage Downlights

Requires 50mm GU10 240V lamp max 50W.

High Quality Cast Aluminium with twist and lock lamp retention bezel & Leaf spring fix in ceiling.

Lamp	Finish	Cut Out (mm)	Ref No.	Order No. 5544
------	--------	--------------	---------	----------------

Fixed

240V GU10	White	72	GZF50 WHI	024411
240V GU10	Brass	72	GZF50 BRS	024424
240V GU10	Chrome	72	GZF50 CHR	024437
240V GU10	Aluminium	72	GZF50 ALM	024440

Tilt

240V GU10	White	82	GZT50 WHI	024453
240V GU10	Brass	82	GZT50 BRS	024466
240V GU10	Chrome	82	GZT50 CHR	024479
240V GU10	Aluminium	82	GZT50 ALM	024482

IP44 Gasket for 50mm Fittings LVG50GAS 024534



GU10 Mains Voltage Downlights

Cast Body Range:

Includes 50W 50mm or 75W 63mm GU10 lamps. Unobtrusive sprung wire retention ring. Coiled spring fix in ceiling - IP44 rated.

Sector Axess range:

Pressed Steel Bezel with unobtrusive sprung wire retention ring. Coiled spring fix in ceiling. Requires 50mm GU10 240V lamp max 50W

Lamp	Finish	Cut Out	Ref No. (mm)	Order No. 0001
------	--------	---------	--------------	----------------

Cast Body - Fixed

240V 50W GU10	White	62	S50FIXW	113349
240V 50W GU10	Brass	62	S50FIXB	113352
240V 50W GU10	Chrome	62	S50FIXC	113365
240V 50W GU10	Satin Chrome	62	S50FIXSCH	125531
240V 75W GU10	White	75	S63FIXW	113404
240V 75W GU10	Brass	75	S63FIXB	113417
240V 75W GU10	Chrome	75	S63FIXC	113420
240V 75W GU10	Satin Chrome	75	S63FIXSCH	125557

Cast Body - Tilt

240V 50W GU10	White	75	S50TILTW	113378
240V 50W GU10	Brass	75	S50TILTB	113381
240V 50W GU10	Chrome	75	S50TILTC	113394
240V 50W GU10	Satin Chrome	75	S50TILTSCH	125544
240V 75W GU10	White	92	S63TILTW	113433
240V 75W GU10	Brass	92	S63TILTB	113446
240V 75W GU10	Chrome	92	S63TILTC	113459
240V 75W GU10	Satin Chrome	92	S63TILTSCH	125560

Pressed Body - Fixed

240V GU10	White	60	ALG50F WHI	141748
240V GU10	Brass	60	ALG50F BRS	141722
240V GU10	Chrome	60	ALG50F CHR	141735
240V GU10	Brushed Chrome	60	ALG50F BCH	141719

Pressed Body - Tilt

240V GU10	White	80	ALG50T WHI	141816
240V GU10	Brass	80	ALG50T BRS	141793
240V GU10	Chrome	80	ALG50T CHR	141803
240V GU10	Brushed Chrome	80	ALG50T BCH	141780



Lighting

RECESSED MAINS 240V DOWNLIGHTS, FIRE PROTECTIVE DOWNLIGHTS



SECTOR

IP44 - GU10 Mains Voltage Shower Lights

Includes 50W GU10 Lamps.

Chrome Steel and acid glass construction.

Attractive slim profile with domed glass.

Cut out dia: 80mm. Void: 70mm.

Description	Finish	Ref No.	Order No. 0001
240V 50W GU10	White	SHOW50G WHI	135466
240V 50W GU10	Chrome	SHOW50G CHR	135479

SECTOR

Cast IP65 GU10 Mains Voltage Downlights

Sector Axess range cast Bezel with large diameter frosted tempered safety glass and moisture seal.

Coiled spring fix in ceiling.

Requires 50mm GU10 240V lamp max 50W.

Lamp	Finish	Cut Out (mm)	Ref No.	Order No. 0001
240V GU10	White	70	ALG50IP65 WHI	141777
240V GU10	Chrome	70	ALG50IP65 CHR	141764
240V GU10	Brushed Chrome	70	ALG50IP65 BCR	141751

FIRE PROTECTIVE DOWNLIGHTS

SECTOR



Cast Fire & Acoustic Downlights

Steel Housing with vent holes incorporating Intumescent material that expands on fire to maintain ceiling integrity up to 90 minutes.

Top quality cast aluminium fitting with twist and lock lamp retention bezel. (IP65 push on bezel with seal).

All fittings include an aluminium forward heat lamp to direct heat away from the rear of the fitting and ceiling void.

Fully BRE (Building Research Establishment) tested and approved.

Lamp	Finish	Cut Out (mm)	Ref No.	Order No. 0001
------	--------	--------------	---------	----------------

Fixed Mains

240V GU10	White	73	SF50GF WHI	141489
240V GU10	Chrome	73	SF50GF CHR	141492
240V GU10	Satin Chrome	73	SF50GF SCH	141502

Tilt Mains

240V GU10	White	86	SF50GT WHI	141515
240V GU10	Chrome	86	SF50GT CHR	141528
240V GU10	Satin Chrome	86	SF50GT SCH	141531

IP65 Mains

240V GU10	White	74	SF50GIP65 WHI	141573
240V GU10	Chrome	74	SF50GIP65 CHR	141586
240V GU10	Satin Chrome	74	SF50GIP65 SCH	141599

Fixed Low Voltage

12V 50mm	White	73	SF50LF WHI	141421
12V 50mm	Chrome	73	SF50LF CHR	141434
12V 50mm	Satin Chrome	73	SF50LF SCH	141447

Tilt Low Voltage

12V 50mm	White	86	SF50LT WHI	141450
12V 50mm	Chrome	86	SF50LT CHR	141463
12V 50mm	Satin Chrome	86	SF50LT SCH	141476

IP65 Low Voltage

12V 50mm	White	74	SF50LIP65 WHI	141544
12V 50mm	Chrome	74	SF50LIP65 CHR	141557
12V 50mm	Satin Chrome	74	SF50LIP65 SCH	141560

Lighting

LOW VOLTAGE LIGHTING TRANSFORMERS



LVT4500

EL-VTH50/3M6V

LVT4503M

ALVT60ED

RECESSED LIGHTING: LOW VOLTAGE LIGHTING TRANSFORMERS

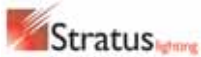

Prewired Low Voltage Transformers

Dimmable with standard resistive dimmer.

High frequency electronic gear for excellent voltage regulation and longer lamp life.

Small 34mm diameter passes through most cut outs.

Description	Ref No.	Order No. 5544
20 - 60VA 12V Cylinder Prewired	LVT4500	440697
20 - 75VA 12V Cylinder Prewired	LVT4501	440095
35 - 105VA 12V Cylinder Prewired	LVT4502	440105

SECTOR

Prewired Mini Transformer

Sector Axess mini low voltage transformer dimmable with standard resistive dimmers.

Small profile fits through a 47mm cut out.

Description	Ref No.	Order No. 0001
60VA 12V 250mm Fly Leads	ALVT60ED	141696
105VA 12V 250mm Fly Leads	ALVT105ED	141706

For soft start grid dimmers suitable for switching low voltage transformers see Page 121



Low Voltage Emergency Conversion Pack

Included Transformer and batteries ensures 3 hour duration both maintained and non maintained for 12V lamps up to 50W.

Fully boxed unit for remote mounting.

Description	Ref No.	Order No. 8274
12V 50W Emergency Conversion	EL-VTH50/3M6V	890996



Toroidal Low Voltage Transformers

Dimmable with inductive dimmers.

Maintenance free Ultra reliable.

Multi output Version have 2.5mm terminals rated at 20 - 50VA.

Single output versions are suitable for remote supply of LV track systems (4mm terminals).

Description	Ref No.	Order No. 5544
50VA 12V Toroidal Pre-wired	LVT4503M	441094

Multi Output Versions

100VA 12V 2Terminal	LVT4504M	441104
150VA 12V 3Terminal	LVT4505M	441117
200VA 12V 4Terminal	LVT4506M	441120
250VA 12V 5Terminal	LVT4507M	441133
300VA 12V 6Terminal	LVT4508M	441146
400VA 12V 8Terminal	LVT4509M	441159
500VA 12V 10Terminal	LVT4510M	441162

Single Output Versions

200VA 12V 1Terminal	LVT4506 M-1	019730
300VA 12V 1Terminal	LVT4508 M-1	019756



Lighting

LOW VOLTAGE LIGHTING TRANSFORMERS & HALOGEN DOWNLIGHTERS



Low Voltage Transformers

Dimmable with standard resistive dimmers.

10 Year guarantee transformers as used in the Sector light kits and packs.

Description	Ref No.	Order No. 0001
Terminated		
20 - 60 VA 12V Loop In / Out + Earth	SLV60TPC2	127775
20 - 60 VA 12V Mini	STEC602	1210726
Pre-Wired		
20 - 60 VA 12V Loop In / Out + Earth	SLV60TDL2	142310
20 - 60 VA 12V Mini	STEC60DL2	126006
20 - 60 VA 12V Slim 13mm	SLVSLIMTRAN2	122466



Terminated Low Voltage Transformers

Top quality easy wire, 10 year guarantee.

Dimmable with standard resistive dimmer.

Loop in Loop out terminals on mains (+ Earth 4518/9).

Screw terminals on LV side 20 / 35 / 50VA.

Description	Ref No.	Order No. 5544
20 - 60VA 12V Prewired	LVT4518	440422
20 - 60VA 12V 3Terminal	LVT4519	440435
35 - 105VA 12V 3 Terminal	LVT45105	028569
50 - 150VA 12V 3 Terminal	LVT4520	440448
70 - 210VA 12V 4 Terminal	LVT4521	440451

RECESSED LIGHTING: LOW VOLTAGE HALOGEN DOWNLIGHTERS



Professional Low Voltage LightPacks

Die Cast Aluminium with twist and lock Bezel retaining a fitted M258 lamp.

IP65 has cast push in Bezel and seal with M258 lamp fitted.

Top quality transformer with loop in loop out mains terminals and LV side pre-wired to lamp holder.

Leaf spring fix in ceiling.

Dimmable with standard resistive dimmer.

Cut Out dia: Fixed - 72mm, Tilt - 82mm. Void: 55mm.

Lamp	Finish	Cut Out (mm)	Ref No.	Order No. 0001
------	--------	--------------	---------	-------------------

Fixed LightPacks

12V 50W	White	72	SLV50FWH2	113093
12V 50W	Brass	72	SLV50FBR2	113103
12V 50W	Chrome	72	SLV50FCH2	113116
12V 50W	Satin Chrome	72	SLV50FSCH2	114348

Tilt LightPacks

12V 50W	White	82	SLV50TWH2	113129
12V 50W	Brass	82	SLV50TBR2	113132
12V 50W	Chrome	82	SLV50TCH2	113145
12V 50W	Satin Chrome	82	SLV50TSCH2	114351

IP65 LightPacks

12V 50W	White	72	SLV50IP65WH2	120329
12V 50W	Brass	72	SLV50IP65BR2	120332
12V 50W	Chrome	72	SLV50IP65CH2	120345
12V 50W	Satin Chrome	72	SLV50IP65SCH2	120358



Lighting

LOW VOLTAGE HALOGEN DOWNLIGHTS



SECTOR

Professional Low Voltage SitePacks

Bulk Sector SitePacks available saving time, money and the environment.

Several fittings packed in 1 partitioned box.

Easily removed and protected fittings & lamp.

Transformers pre-wired to lamp holder have loop in loop out plus earth terminals on mains side.

Lamp	Finish	Ref No.	Order No. 0001
------	--------	---------	----------------

Fixed SitePacks of 10 Kits

12V 50W	White	SLV50FWH2P10	122424
12V 50W	Brass	SLV50FBR2P10	124794
12V 50W	Chrome	SLV50FCH2P10	122437
12V 50W	Satin Chrome	SLV50FSCH2P10	124781

Tilt SitePacks of 10 Kits

12V 50W	White	SLV50TWH2P10	122440
12V 50W	Brass	SLV50TBR2P10	124804
12V 50W	Chrome	SLV50TCH2P10	122453
12V 50W	Satin Chrome	SLV50TSCH2P10	124778

IP65 SitePacks of 5 Kits

12V 50W	White	SLV50IP65WHP5	136258
12V 50W	Chrome	SLV50IP65CHP5	136261
12V 50W	Satin Chrome	SLV50IP65SCHP5	136274

SECTOR

Low Voltage Eyeball LightPacks

Pressed Steel Eyeball Lightpack with.

Pre-wired sector transformer & M258 lamp.

Lamp retention with dark metal spring.

Spring fix to ceiling.

Dimmable with standard resistive dimmer.

Lamp	Finish	Cut Out (mm)	Ref No.	Order No. 0001
12V 50w	White	86	SLV50EWH2	115648
12V 50w	Brass	86	SLV50EBR2	115651
12V 50w	Chrome	86	SLV50ECH2	115664
12V 50w	Satin Chrome	86	SLV50ESCH2	115677

Stratus lighting

50mm Low Voltage Scoop Downlights

Requires a transformer and 50mm LV lamp.

Very high quality cast aluminium construction providing 355° rotational and 60° vertical adjustment.

Connection box & lamp holder on detachable up stand.

Easy lamp change via cast bezel mechanism.

Leaf spring fix into ceiling.

Lamp	Finish	Cut Out (mm)	Ref No.	Order No. 5544
12V 50mm	White	100	LVS50 WHI	025494
12V 50mm	Brass	100	LVS50 BRS	025517
12V 50mm	Chrome	100	LVS50 CHR	025504
12V 50mm	Aluminium	100	LVS50 ALM	025520

SECTOR plus

Lighting

LOW VOLTAGE HALOGEN DOWNLIGHTS

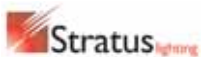

35 & 50mm Low Voltage Downlights

Fixed and Tilt Versions:

- Individual fittings similar to the Sector Professional Kits.
- Requires a transformer and 50mm or 35mm LV lamp.
- Aluminium Cast twist and lock lamp retention Bezel.
- Connection box & lamp holder on detachable up stand.
- Leaf spring fix in ceiling (35mm coiled spring fix).

Lamp	Finish	Cut Out (mm)	Ref No.	Order No. 5544
Fixed				
12V 35mm	White	53	LVF35 WHI	024259
12V 35mm	Brass	53	LVF35 BRS	024262
12V 35mm	Chrome	53	LVF35 CHR	024275
12V 35mm	Aluminium	53	LVF35 ALM	024288
12V 50mm	White	72	LVF50 WHI	024330
12V 50mm	Brass	72	LVF50 BRS	024343
12V 50mm	Chrome	72	LVF50 CHR	024356
12V 50mm	Aluminium	72	LVF50 ALM	024369
Tilt				
12V 35mm	White	63	LVT35 WHI	024291
12V 35mm	Brass	63	LVT35 BRS	024301
12V 35mm	Chrome	63	LVT35 CHR	024314
12V 35mm	Aluminium	63	LVT35 ALM	024327
12V 50mm	White	82	LVT50 WHI	024372
12V 50mm	Brass	82	LVT50 BRS	024385
12V 50mm	Chrome	82	LVT50 CHR	024398
12V 50mm	Aluminium	82	LVT50 ALM	024408
IP44 Gasket for 50mm fittings			LVG50GAS	024534



50mm Low Voltage Downlights

- Requires 50mm 12V lamps and transformer.
- Sector Axess range pressed steel or cast aluminium construction.
- IP65 has bezel with large diameter frosted tempered safety glass.
- Coiled spring fix in ceiling.
- Sprung steel lamp retention ring or cast twist and lock bezel.
- Connection box and lampholder on detachable upstand.

Lamp	Finish	Cut Out (mm)	Ref No.	Order No. 0001
Pressed Steel - Fixed				
12V 50mm	White	60	ALV50F WHI	141858
12V 50mm	Brass	60	ALV50F BRS	141832
12V 50mm	Chrome	60	ALV50F CHR	141845
12V 50mm	Brushed Chrome	60	ALV50F BCH	141829
Pressed Steel - Tilt				
12V 50mm	White	80	ALV50T WHI	141939
12V 50mm	Brass	80	ALV50T BRS	141913
12V 50mm	Chrome	80	ALV50T CHR	141926
12V 50mm	Brushed Chrome	80	ALV50T BCH	141900
Cast Aluminium - Fixed				
12V 50mm	White	70	ALVD50F WHI	142022
12V 50mm	Brass	70	ALVD50F BRS	142006
12V 50mm	Chrome	70	ALVD50F CHR	142019
12V 50mm	Brushed Chrome	70	ALVD50F BCH	141997
Cast Aluminium - Tilt				
12V 50mm	White	82	ALVD50T WHI	142064
12V 50mm	Brass	82	ALVD50T BRS	142048
12V 50mm	Chrome	82	ALVD50T CHR	142051
12V 50mm	Brushed Chrome	82	ALVD50T BCH	142035
Cast Aluminium - IP65				
12V 50mm	White	70	ALV50IP65 WHI	141890
12V 50mm	Chrome	70	ALV50IP65 CHR	141887
12V 50mm	Brushed Chrome	70	ALV50IP65 BCR	141861



Lighting

LOW VOLTAGE HALOGEN DOWNLIGHTS & FIBRE OPTIC LIGHTING



Low Voltage Lighting Bars

Complete fitting housing a transformer and switch, supplied with mains powercord.

Includes M47 20W low voltage capsule lamp.

Description	Finish	Length (mm)	Ref No.	Order No. 0001
12V 2 x 20W	White	535	ALVBAR2X20 WHI	141942
12V 3 x 20W	White	800	ALVBAR3X20 WHI	141955



Low Voltage Cabinet Downlights

Tiny robust fittings that include a lamp and prewired with 2m of cable ideal for mounting under cabinets lighting the work surface.

All fittings require a transformer.

Includes M47 20W low voltage capsule lamp.

Lamp	Finish	Cut Out (mm)	Ref No.	Order No. 0001
Single Surface / Recessed				
12V 20W	White	54	ALVCAB1X20 WHI	141984
12V 20W	Brass	54	ALVCAB1X20 BRS	141968
12V 20W	Chrome	54	ALVCAB1X20 CHR	141971

Triangle Surface

12V 20W	Brushed Chrome		ALVTR1X20 BCH	142077
---------	----------------	--	---------------	--------



Low Voltage Slim LightPacks

Pack consists of 3x20W downlights & M47 capsule lamps with slimline (13mm) 60VA transformer & flexible cable.

Fittings have a removable surface ring that allows for recess mounting.

Cut Out: 59mm, Recess Depth: 25mm, Surface Depth: 30mm.

Dimmable with standard resistive dimmer.

Description	Ref No.	Order No. 0001
3 x 20W Undershelf Kit White	SLVSLIMWH2	113475
3 x 20W Undershelf Kit Brass	SLVSLIMBR2	114364
3 x 20W Undershelf Kit Chrome	SLVSLIMCH2	114377

RECESSED LIGHTING: FIBRE OPTIC LIGHTING



Lightpoint Star Kit

Customised lighting effects with these low cost easy fit fibre optic kits.

The glass harness transmits brilliant light from a remote box over many points at low temperature via fibre optic cable.

Internal spinning disc twinkles light.

Low maintenance-only one lamp in remote light box for many points of light.

The 120 1.2M Tails ends are mounted into the ceiling using the 5.5mm dia. Ferrules included in kit.

Description	Ref No.	Order No. 5544
35W 120Tail Blue / White Twinkle	FO-STARKIT 1	022073



Lighting

LOW ENERGY DOWNLIGHTS



RECESSED LIGHTING: LOW ENERGY DOWNLIGHTERS

SECTOR



Vertical CFL Downlights

Includes 4 Pin triple turn CFL lamp.

Lightweight injection moulding supplied with white bezel and lamp, pre-wired with 1m flying lead.

Class II insulation no earth required.

Cut Out: 90mm. Void: 150mm.

Description	Ref No.	Order No. 0001
13W HF CFL Downlight White	SCFV13L	134959
18W HF CFL Downlight White	SCFV18L	134962
26W HF CFL Downlight White	SCFV26L	134975
Brass Bezel	SCFV110 BRS	135000
Chrome Bezel	SCFV110 CHR	134991
Blue Deco Halo	SCFV70 BLU	135026
Clear IP44 cover	SCFV44 CLR	135013

SECTOR



GU10 CFL Downlights

PVC Bezel with unique lamp retention ensures only the included.

9W GU10 cap CFL lamp can be used in fitting.

Cut Out: 70mm. Void: 120mm.

Description	Ref No.	Order No. 0001
9W GU10 Downlight White	SCF9GU WHI	135330
9W GU10 Downlight Chrome	SCF9GU CH	135343

Stratus lighting



Vertical CFL Downlights

Requires 4 pin triple turn CFL lamp.

Integral quickstart high frequency electronic ballast.

0-10v dimmable available to order.

Lightweight and prewired with easy tri-wing fixtures to ceilings between 1 to 30mm thick.

Emergency gear is mounted remotely.

Supplied with White plastic bezel.

Description	Cut Out (mm)	Void (mm)	Ref No.	Order No. 5544
-------------	-----------------	--------------	---------	-------------------

Compact VPL

1 x 18WTC-TE 4P HF	130	175	VPL5702-T	570017
1 x 26WTC-TE 4P HF	130	175	VPL5703-T	570020

Compact VPL - Emergency

1 x 26WTC-TE 4P HF	130	175	VPL5702-T-E3	570198
1 x 26WTC-TE 4P HF	130	175	VPL5703-T-E3	570185

Compact VPL Accessories

IP44 Glass Bezel Cast White	PLB5719 WHI	570279
Floating Glass Bezel Cast White	PLB5722 WHI	570240
Centre Hole Floating Glass White	PLB5723 WHI	570237
IP20 Cast Bezel Chrome	PLB5718 CHR	019785

Standard VPL

1 x 18WTC-TE 4P HF	185	265	VPL5704-T	570059
1 x 26WTC-TE 4P HF	185	265	VPL5705-T	570062
1 x 32WTC-TE 4P HF	185	265	VPL5706-T	570075

Standard VPL - Emergency

1 x 18WTC-TE 4P HF	185	265	VPL5704-T-E3	570156
1 x 26WTC-TE 4P HF	185	265	VPL5705-T-E3	570305
1 x 32WTC-TE 4P HF	185	265	VPL5706-T-E3	570318

Standard VPL Downlights use Standard Accessories as used on Stratus HPL.

SECTOR Plus

Lighting

LOW ENERGY DOWNLIGHTS

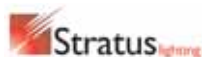

Standard CFL Downlight Accessories

Simple twist and lock locates these bezels onto Stratus VPL and HPL Standard CFL downlights.

IP65, Polycarb and other colour Bezels are available to order.

Description	Ref No.	Order No. 5544
IP20 Cast Bezel White	PLB5710 WHI	570088
IP20 Cast Bezel Brass	PLB5710 BRS	570101
IP20 Cast Bezel Chrome	PLB5710 CHR	019824
IP44 Glass Bezel Cast White	PLB5711 WHI	570091
Floating Glass Bezel Cast White	PLB5714 WHI	570127
Centre Hole Floating Glass White	PLB5715 WHI	570130
Push in Category 2 Reflector	PLB2CAT2	022057



All Stratus fluorescent fittings are available to order with 0-10v dimmable ballasts and can be dimmed with Sector grid dimmers see Page 121.



Horizontal CFL Downlights



Switch Start require 2 pin double turn CFL lamps.

Switch Start Emergency require 1 x 2pin & 1 x 4pin double turn CFL lamps.

HF & HF Emergency Require 4 pin triple turn CFL lamps.

Lightweight, loop in loop out terminations with easy tri-wing fixtures to ceilings between 1 to 30mm thick.

All lamp control gear is mounted internally. Emergency gear is mounted remotely.

Supplied with White plastic bezel.

Cut Out dia: 185mm. Length: 344mm. Void S/S: 148mm. HF: 125mm.

Description	Ref No.	Order No. 5544
-------------	---------	-------------------

Switch Start Single

1 x 18WTC-D 2PIN S/S	HPL118SS	560658
1 x 26WTC-D 2PIN S/S	HPL126SS	018854
1 x 18WTC-DE 4Pin S/S Emergency	HPL118SS E3	560771
1 x 26WTC-DE 4Pin S/S Emergency	HPL126SS E3	560784

Switch Start Twin

2 x 18WTC-D 2PIN S/S	HPL218SS	560674
2 x 26WTC-D 2PIN S/S	HPL226SS	560687
2 x 18WTC-D/E 2P&4P S/S Emergency	HPL218SS E3	560807
2 x 26WTC-D/E 2P&4P S/S Emergency	HPL226SS E3	560810

High Frequency Single

1 x 18WTC-DE 4PIN HF	HPL5601-D	567949
1 x 26WTC-TE 4PIN HF	HPL5602-T	560056
1 x 32WTC-TE 4PIN HF	HPL5603-T	560043
1 x 42WTC-TE 4PIN HF	HPL5606-T	019866
1 x 18WTC-DE 4PIN HF Emergency	HPL5601-D E3	560098
1 x 26WTC-TE 4PIN HF Emergency	HPL5602-T E3	560108
1 x 32WTC-TE 4PIN HF Emergency	HPL5603-T E3	560111
1 x 42WTC-TE 4PIN HF Emergency	HPL5606-T E3	019879

High Frequency Twin

2 x 18WTC-DE 4PIN HF	HPL5605-D	560014
2 x 18WTC-TE 4PIN HF	HPL5607-T	560027
2 x 26WTC-TE 4PIN HF	HPL5608-T	560030
2 x 18WTC-DE 4PIN HF Emergency	HPL5605-D E3	560137
2 x 18WTC-TE 4PIN HF Emergency	HPL5607-T E3	560140
2 x 26WTC-TE 4PIN HF Emergency	HPL5608-T E3	560292

Lighting

DISCHARGE DOWNLIGHTS

MHFD070



MIDS035



RECESSED LIGHTING: DISCHARGE DOWNLIGHTERS

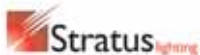

Fixed Halide Downlights

Requires a Quartz or Ceramic double ended metal halide lamp.

Designed for retail or commercial applications inside or out these highly efficient luminaires provide high levels of illumination with superb colour rendering.

Prewired to remote magnetic gear.

Cut Out: 165mm. Void: 140mm. Beam 30°.

Description	Ref No.	Order No. 5544
70W Fixed Halide White	MHFD070	024783
150W Fixed Halide White	MHFD150	024822



Round Midi Scoop Halide Downlights

Includes Ceramic Metal Halide capsule lamp colour 830 CDMTC
20° Beam angle reflector.

These luminaires feature a die cast body offering 355°
rotational and 60° vertical adjustment.

Prewired to remote magnetic gear.

Description	Cut Out x Void (mm)	Ref No.	Order No. 5544
35W IP44, White	138 x 120	MIDS035	025164
70W IP44, White	138 x 120	MIDS070	025193

Lighting

DISCHARGE DOWNLIGHTS

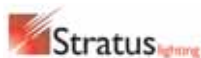

Round Maxi Scoop Halide Downlights

Requires a Quartz or Ceramic Single ended metal halide lamp G12 24° Beam angle reflector.

These luminaires feature a die cast body offering 355° rotational and 60° vertical adjustment.

Prewired to remote magnetic gear.

Description	Cut Out x Void (mm)	Ref No.	Order No. 5544
70W IP44, White	166 x 145	MAXS070	024945
150W IP44, White	166 x 145	MAXS150	024974



Square Scoop (Tilt 2 x 45°) Halide Downlights

Require a Quartz or Ceramic double ended metal halide lamp.

High output luminaires perfect for wall wash and display lighting in many applications.

Quick and easy plug and socket connections between luminaire and remote magnetic gear.

Cut Out: 228mm x 176mm.

Description	Ref No.	Order No. 5544
70W TD/RX7 Halide White	MHST1070	025960
150W TD/RX7 Halide White	MHST1150	025973



Square Scoop (Swing 60°) Halide Downlights

Requires a Quartz or Ceramic double ended metal halide lamp.

High output luminaires perfect for wall wash and display lighting in many applications.

Quick and easy plug and socket connections between luminaire and remote magnetic gear.

Cut Out: 202mm x 150mm.

Description	Ref No.	Order No. 5544
70W TD/RX7 Halide White	MHSS1070	026053
150W TD/RX7 Halide White	MHSS1150	026066



Lighting

RECESSED MODULAR

FMECON663



FMECON1264



RECESSED LIGHTING: MODULAR

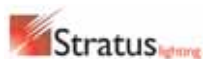

Econ Layin Body Only (Switch Start)

Market leading product in an extensive range of options.

Requires T8 Fluorescent tubes and louvre or panel.

Suitable for both 15mm and 25mm exposed T ceilings.

The Louvre however must be sized to ceiling dimension

Fitting lifts and tilts in ceiling void: 280mm required.

All gear is integral in fitting.

Further body and gear options are available to order.

Description	Ref No.	Order No. 5544
-------------	---------	-------------------

Switch Start

600 x 600 3 x 18W	FMECON663	116332
600 x 600 4 x 18W	FMECON664	116374
1200 x 600 4 x 36W	FMECON1264	116219

Switch Start Emergency

600 x 600 3 x 18W	FMECON663 E3	116345
600 x 600 4 x 18W	FMECON664 E3	116387
1200 x 600 4 x 36W	FMECON1264 E3	116222



High Frequency

Integral High Frequency control gear provides instant start with longer lamp life.

Flicker free operation independent of mains voltage fluctuations also provides reliable operation and long service life.

Used in conjunction with Triphosphor tubes up to 20% energy saving can be achieved.



Description	Ref No.	Order No. 5544
-------------	---------	-------------------

High Frequency

600 x 600 3 x 18W	FMECON663 HF	116358
600 x 600 4 x 18W	FMECON664 HF	116390
1200 x 600 4 x 36W	FMECON1264 HF	116235

High Frequency Emergency

600 x 600 3 x 18W	FMECON663 HFE3	116361
600 x 600 4 x 18W	FMECON664 HFE3	116400
1200 x 600 4 x 36W	FMECON1264 HFE3	116248

Fire tents suitable for these fittings are available

Lighting

RECESSED MODULAR



Layin Louvres and Panels

Requires Stratus Econ body.

The prismatic panels are suitable for both 15mm and 25mm exposed T ceilings.

The Louvre must be sized to ceiling T dimension.

Description	Ref No.	Order No. 5544
Standard Low Brightness Louvres - 15mm T Grid		
600 x 600 3 Lamp for 15mm T Grid	FMSTDL 663NT	114790
600 x 600 4 Lamp for 15mm T Grid	FMSTDL 664NT	114127
1200 x 600 4 Lamp for 15mm T Grid	FMSTDL 1264NT	114693
Category 2 65° - 15mm T Grid		
600 x 600 3 Lamp for 15mm T Grid	FMCA2L 663NT	114091
600 x 600 4 Lamp for 15mm T Grid	FMCA2L 664NT	114101
1200 x 600 4 Lamp for 15mm T Grid	FMCA2L 1264NT	110066
Standard Low Brightness Louvres - 25mm T Grid		
600 x 600 3 Lamp for 25mm T Grid	FMSTDL 663ST	110008
600 x 600 4 Lamp for 25mm T Grid	FMSTDL 664ST	110011
1200 x 600 4 Lamp for 25mm T Grid	FMSTDL 1264ST	110037
Category 2 65° - 25mm T Grid		
600 x 600 3 Lamp for 25mm T Grid	FMCA2L 663ST	110105
600 x 600 4 Lamp for 25mm T Grid	FMCA2L 664ST	110118
1200 x 600 4 Lamp for 25mm T Grid	FMCA2L 1264ST	110134

Description	Ref No.	Order No. 5544
Prismatic Panels TP(b)		
600 x 600 2 - 4 Lamp Styrene	FMPD 66	110215
1200 x 600 2 - 4 Lamp Styrene	FMPD 126	110231
Prismatic Panels TP(a) Fire Rated		
600 x 600 2 - 4 Lamp PVC	FMPA 66	114651
1200 x 600 2 - 4 Lamp PVC	FMPA 126	116947

Lighting

RECESSED MODULAR

FMDU0664 C2

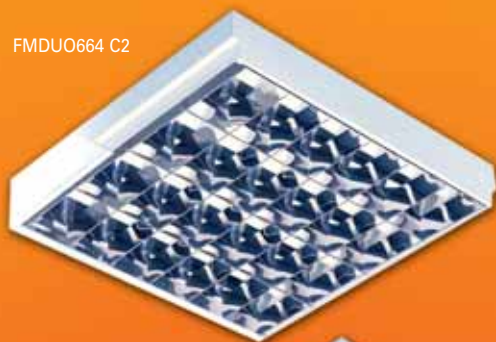

SCF664C2L



FMDU0664 PD



FMPR664 C2

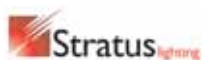

Duo Combined Layin and Controllers

Requires T8 Fluorescent tubes.

Suitable for both 15mm and 25mm exposed T ceilings.

Louvre lifts and tilts within the fitting not the ceiling.

Packed as one unit. Further body and gear options readily available.

Description	Ref No.	Order No. 5544
-------------	---------	-------------------

Switchstart

600 x 600 4 x 18W	FMDU0664 C2	117496
600 x 600 4 x 18W Emergency	FMDU0664 E3C2	117506
1200 x 600 4 x 36W	FMDU01264 C2	117739
1200 x 600 4 x 36W Emergency	FMDU01264 E3C2	117742

High Frequency

600 x 600 4 x 18W	FMDU0664 HFC2	117519
600 x 600 4 x 18W Emergency	FMDU0664 HFE3C2	117522

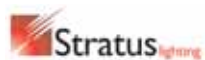

Duo Combined Layin and Diffuser

Requires T8 Fluorescent tubes.

Suitable for both 15mm and 25mm exposed T ceilings.

Prismatic panel lifts and tilts within the fitting not the ceiling.

Packed as one unit.

Further body and gear options readily available.

Description	Ref No.	Order No. 5544
-------------	---------	-------------------

600 x 600 4 x 18W Switch Start	FMDU0664 PD	117412
600 x 600 4 x 18W High Frequency	FMDU0664 HFPD	117438



Future Easy Fix Lay in Mod

Switch start Includes: T8 White col 35 Fluorescent Tubes.

High Frequency Includes: T8 Triphosphor col 835 Fluorescent Tubes.

Fitted with pre-stripped & tinned 3M LSF flex for speedy installation.

Complete with Cat 2 louvre with easy peel protective film ensuring unit remains clean until ready for use.

Suitable for both 15mm and 25mm exposed T 600 x 600 ceilings.

Description	Ref No.	Order No. 0001
-------------	---------	-------------------

600 x 600 4 x 18W Switch Start C2	SCF664C2L	125573
600 x 600 4 x 18W S/S C2 Emergency	SCF664C2E3L	125586
600 x 600 4 x 18W High Frequency C2	SCF664HFC2L	125599
600 x 600 4 x 18W HF C2 Emergency	SCF664HFC2E3L	125609



Premier Mod Pull Up and Louvre

Requires T8 Fluorescent tubes.

A high quality trimmed luminaire compatible with a wide variety of ceiling types including Plasterboard, spring tee, metal pan and exposed tee.

Many other louvre and body options available to order.

Description	Ref No.	Order No. 5544
-------------	---------	-------------------

600 x 600 4 x 18W High Frequency C2	FMPR664 HFC2	113432
600 x 600 4 x 18W HF C2 Emergency	FMPR664 HFE3C2	113445



Lighting

RECESSED MODULAR



FMWWR63 155PLHF



STM55IDC2



STM55ID

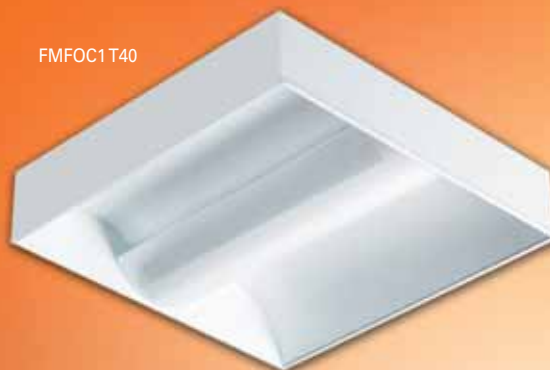

FMFOC1T40

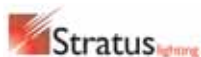

Wallwash Layin Mod

Requires 4 Pin 55WTCL CFL lamps.

High frequency gear as standard.

Lays into an exposed tee ceiling (Surface & pull up versions available).

An asymmetric wallwash luminaire which offers both vertical and angular lamination, ideal for retail environments.

Description	Ref No.	Order No. 5544
600 x 300 1 x 55W HF Wallwash	FMWWR63 155PLHF	011039
1200 x 300 2 x 55W HF Wallwash	FMWWR123 255PLHF	011042



Direct / Indirect HF Layin Mod

Includes 2 x 55wTCL lamps col 835.

High Frequency gear as standard.

The fitting lays in to the 600 x 600 ceiling. Attachment is fitted by clipping onto fixings mounted in to the body.

Opal polycarbonate reeded curved wing diffuser attachment.

Description	Ref No.	Order No. 0001
600 x 600 2 x 55WTCL HF	STM55ID	135835
600 x 600 2 x 55W TCL HF Emergency	STM55ID/E3	135848



Direct / Indirect HF Layin Mod

Includes 2 x 55w TCL lamps col 835.

High Frequency gear as standard.

The fitting lays in to the 600 x 600 ceiling. Attachment is fitted by clipping onto fixings mounted into the body.

Opal polycarbonate reeded curved wing diffuser attachment with semi specular aluminium louvre.

Description	Ref No.	Order No. 0001
600 x 600 2 x 55WTCL HF	STM55IDC2	135851
600 x 600 2 x 55WTCL HF Emergency	STM55IDC2/E3	135864



Focus Central Perforated Flush Basket

Requires 4 Pin 40W or 55WTCL CFL lamps.

Layin to Exposed T ceiling fixing as standard.

Also available in other Gear, lamp, body & louvre options.

Description	Ref No.	Order No. 5544
600 x 600 2 x 40WTCL HF	FMFOC1T40	006329
600 x 600 2 x 40WTCL HF Emergency	FMFOC1T40E3	006332
600 x 600 2 x 55WTCL HF	FMFOC1T55	006345
600 x 600 2 x 55WTCL HF Emergency	FMFOC1T55E3	006358



Lighting

RECESSED MODULAR

FMFOC1DBT40



FMPRT5 414C2



FMFOC2T40



FMPRT5ID 414C2

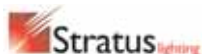

Focus Central Perforated Drop Basket

Requires 4 Pin 40W or 55WTCL CFL lamps.

Lay in to Exposed T ceiling fixing as standard.

Also available in other Gear, lamp, body & louvre options.

Description	Ref No.	Order No. 5544
600 x 600 2 x 40WTCL HF	FMFOC1DBT40	030340
600 x 600 2 x 40WTCL HF Emergency	FMFOC1DBT40E3	030353
600 x 600 2 x 55WTCL HF	FMFOC1DBT55	030382
600 x 600 2 x 55WTCL HF Emergency	FMFOC1DBT55E3	030395



Premier Mod T5

Includes T5 14W Colour 840 High Efficiency Fluorescent tubes.

Pull Up will fit most ceilings and in voids as low as 75mm.

Lay In fits both 15mm & 25mm TBar ceilings.

Also available in other Gear, lamp, body & louvre options.

Description	Ref No.	Order No. 5544
-------------	---------	-------------------

Pull Up

600x600 4 x 14WT5 HE C2	FMPRT5 414C2	006934
600x600 4 x 14WT5 HE C2 Emergency	FMPRT5 414E3C2	006947

Lay In

600x600 4 x 14WT5 HE C2	FMPRLT5 414C2	029490
600x600 4 x 14WT5 HE C2 Emergency	FMPRLT5 414E3C2	029500

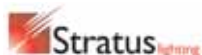

Focus Central Category 2 Louvre & Basket

Requires 4 Pin 40W or 55WTCL CFL lamps.

Lay in to Exposed T ceiling fixing as standard.

Also available in other Gear, lamp, body & louvre options.

Description	Ref No.	Order No. 5544
600 x 600 2 x 40WTCL HF	FMFOC2T40	006361
600 x 600 2 x 40WTCL HF Emergency	FMFOC2T40E3	006374
600 x 600 2 x 55WTCL HF	FMFOC2T55	006387
600 x 600 2 x 55WTCL HF Emergency	FMFOC2T55E3	006390



Premier Mod T5 - Indirect

Includes T5 14W Colour 840 High Efficiency Fluorescent tubes.

High frequency control gear as standard.

Super slim mod featuring the latest technology and helps achieve LG3 2001 compliant schemes.

Also available in other Gear, lamp, body & louvre options.

Pulls up into most ceilings & voids as low as 75mm.

Description	Ref No.	Order No. 5544
-------------	---------	-------------------

600 x 600 4 x 14WT5 HE C2	FMPRT5ID 414C2	020635
600 x 600 4 x 14WT5 HE C2 Emergency	FMPRT5ID 414E3C2	020648

Lighting

RECESSED & SURFACE MODULAR

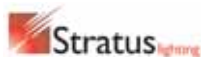

Impervia Recessed IP65

Requires 2FT 18WT8 Fluorescent tubes - See page 15.

A robust, pull-up luminaires for use in clean area environments.

Jet proof from above and below the ceiling.

Also available in other Gear, lamp, body & louvre options.

Description	Ref No.	Order No. 5544
600 x 600 4 x 18W High Frequency	FMIMPR 664HF	011178
600 x 600 4 x 18W HF Emergency	FMIMPR 664HFE3	011440

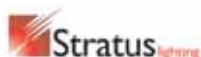

Impervia Recessed IP54

Requires 2FT 18WT8 Fluorescent tubes - See page 15.

A robust, pull-up luminaires for use in clean area environments.

Splash proof from below the ceiling.

Also available in other Gear, lamp, body & louvre options.

Description	Ref No.	Order No. 5544
600 x 600 4 x 18W Switch Start	FMIMPR(54) 664	011495
600 x 600 4 x 18W S/S Emergency	FMIMPR(54) 664E3	011547
600 x 600 4 x 18W High Frequency	FMIMPR(54) 664HF	011592
600 x 600 4 x 18W HF Emergency	FMIMPR(54) 664HFE3	011644

SURFACE: MODULAR LIGHTING

A versatile surface mounted linear luminaire, with attractive low profile bevelled edge steel body.

Profiled body style complemented with durable plastic end-caps.

Lift and tilt' CIBSE LG3(2001) C2 65° louvres.

Body profile allows for continuous run mounting.

A combination of BESA entries and suspension points allows this luminaire to be mounted on or suspended from most ceilings.

Further body, gear, lamp and diffuser options are available.



Sleek High Frequency

Integral High Frequency control gear provides instant start with longer lamp life.

Flicker free operation independent of mains voltage fluctuations also provides reliable operation and long service life.

Used in conjunction with Triphosphor tubes up to 20% energy saving can be achieved.

Emergency versions are integral 3 hour maintained.

Requires T8 fluorescent tubes.

Length	Size (mm)	Lamp	Ref No.	Order No. 5544
Single Lamp Cat 2 Louvre				
5Ft	1500 x 200	1 x 58W	FMSLK1521 HFC2	115278
6Ft	1800 x 200	1 x 70W	FMSLK1821 HFC2	115919

Twin Lamp Cat 2 Louvre

5Ft	1500 x 200	2 x 58W	FMSLK1522 HFC2	115524
6Ft	1800 x 200	2 x 70W	FMSLK1822 HFC2	116031

Emergency Twin Lamp Cat 2 Louvre - Maintained

5Ft	1500 x 200	2 x 58W	FMSLK1522 HFE3C2	115647
6Ft	1800 x 200	2 x 70W	FMSLK1822 HFE3C2	116015

Lighting

SURFACE MODULAR

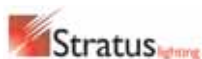

Sleek Switch Start Single

Switch start High power factor control gear.

Single lamps for use where lower light levels are required from the same body size as twins.

Requires a single T8 fluorescent tube.

Length	Size (mm)	Lamp	Ref No.	Order No. 5544
Single Lamp Cat 2 Louvre				
4Ft	1200 x 200	1 x 36W	FMSLK1221 C2	117894
5Ft	1500 x 200	1 x 58W	FMSLK1521 C2	115236
6Ft	1800 x 200	1 x 70W	FMSLK1821 C2	115731

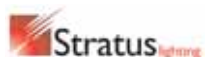

Sleek Switch Start Twin

Switch start High power factor control gear.

Emergency versions are integral 3 hour maintained.

Requires two T8 fluorescent tubes.

Length	Size (mm)	Lamp	Ref No.	Order No. 5544
Twin Lamp Cat 2 Louvre				
4Ft	1200 x 200	2 x 36W	FMSLK1222 C2	114994
5Ft	1500 x 200	2 x 58W	FMSLK1522 C2	115472
6Ft	1800 x 200	2 x 70W	FMSLK1822 C2	115883

Emergency Twin Lamp Cat 2 Louvre - Maintained

4Ft	1200 x 200	2 x 36W	FMSLK1222 E3C2	115113
5Ft	1500 x 200	2 x 58W	FMSLK1522 E3C2	115605
6Ft	1800 x 200	2 x 70W	FMSLK1822 E3C2	115977

All Stratus fluorescent fittings are available to order with 0-10v dimmable ballasts and can be dimmed with Sector grid dimmers see Page 121.



Premier Sleek Surface Mod with Cat 2 Louvre

A versatile surface mounted modular luminaire, with attractive low profile body.

Slim steel sides and end caps and highly polished louvre.

Requires four T8 fluorescent tubes.

Length	Size (mm)	Lamp	Ref No.	Order No. 5544
Switch Start				
2Ft	600 x 600	4 x 18W	FMPSLK664 C2	006633
Switch Start Emergency Integral Maintained				
2Ft	600 x 600	4 x 18W	FMPSLK664 E3C2	007823

High Frequency

2Ft	600 x 600	4 x 18W	FMPSLK664 HFC2	007085
-----	-----------	---------	----------------	--------

High Frequency Emergency Integral Maintained

2Ft	600 x 600	4 x 18W	FMPSLK664 HFE3C2	007454
-----	-----------	---------	------------------	--------

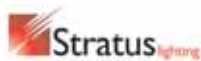

Focus Linear HF Indirect

A modern contemporary surface mounted louvred luminaire that is a stylish alternative to the conventional louvred type surface linear and ideal for general & most office lighting.

It is designed to provide a mild, indirect illumination to any interior where a comfortable atmosphere is desired.

White steel body and perforated drop basket with a white aluminium reflector.

Requires two T8 fluorescent tubes.

Length	Size (mm)	Lamp	Ref No.	Order No. 5544
High Frequency				
5Ft	1500 x 280	2 x 58W	FOC7LINT58	031530
6Ft	1800 x 280	2 x 70W	FOC7LINT70	031556
High Frequency Emergency - Maintained				
5Ft	1500 x 280	2 x 58W	FOC7LINT58E3	031543
6Ft	1800 x 280	2 x 70W	FOC7LINT70E3	031569

Lighting

IP65 WEATHERPROOF BATTENS WITH ACRYLIC DIFFUSER



IP65 WEATHERPROOF BATTENS WITH ACRYLIC DIFFUSER

Glass reinforced polyester body.

High Impact interior stippled Acrylic diffuser.

Dust and Jet Proof to IP65.

Integral emergency versions are 3 hour maintained.

Diffuser is retained with plastic latches with the option of stainless steel tamper resistant clips available.

Ideal for food factories, shower and changing rooms and moist environments.



Acrylic Weatherproof High Frequency

Integral High Frequency control gear provides instant start with longer lamp life.

Flicker free operation independent of mains voltage fluctuations also provides reliable operation and long service life.

Used in conjunction with Triphosphor tubes up to 20% energy saving can be achieved.

Single: W 115mm x H 105mm. Twin: W 185mm x H 105mm.

Requires T8 Fluorescent tubes.

Length	Size	Lamp	Ref No.	Order No.
				0001

Single High Frequency

4Ft	1.2m	1 x 36W	SCA4136HF	142433
5Ft	1.5m	1 x 58W	SCA5158HF	142475
6Ft	1.8m	1 x 70W	SCA6170HF	142514

Single High Frequency Emergency - Maintained

4Ft	1.2m	1 x 36W	SCA4136HF E3	142446
5Ft	1.5m	1 x 58W	SCA5158HF E3	142488
6Ft	1.8m	1 x 70W	SCA6170HF E3	142527

Twin High Frequency

4Ft	1.2m	2 x 36W	SCA4236HF	142569
5Ft	1.5m	2 x 58W	SCA5258HF	142608
6Ft	1.8m	2 x 70W	SCA6270HF	142640

Twin High Frequency Emergency - Maintained

4Ft	1.2m	2 x 36W	SCA4236HF E3	142572
5Ft	1.5m	2 x 58W	SCA5258HF E3	142611
6Ft	1.8m	2 x 70W	SCA6270HF E3	142653

Vandal Resistant Stainless Steel SCAWP1/SS 142925
Diffuser Clips. 2 Required Per Foot (2/300mm)



Acrylic Weatherproof Switch Start

Integral switch start high power factor control gear.

Single Width 115mm, Height 105mm.

Twin Width 185mm, Height 105mm.

Requires T8 Fluorescent tubes.

Length	Size	Lamp	Ref No.	Order No.
				0001

Single Switch Start

2Ft	0.6m	1 x 18W	SCA2118	142404
4Ft	1.2m	1 x 36W	SCA4136	142417
5Ft	1.5m	1 x 58W	SCA5158	142459
6Ft	1.8m	1 x 70W	SCA6170	142491

Single Switch Start Emergency - Maintained

4Ft	1.2m	1 x 36W	SCA4136 E3	142420
5Ft	1.5m	1 x 58W	SCA5158 E3	142462
6Ft	1.8m	1 x 70W	SCA6170 E3	142501

Twin Switch Start

2Ft	0.6m	2 x 18W	SCA2218	142530
4Ft	1.2m	2 x 36W	SCA4236	142543
5Ft	1.5m	2 x 58W	SCA5258	142585
6Ft	1.8m	2 x 70W	SCA6270	142624

Twin Switch Start Emergency - Maintained

4Ft	1.2m	2 x 36W	SCA4236 E3	142556
5Ft	1.5m	2 x 58W	SCA5258 E3	142598
6Ft	1.8m	2 x 70W	SCA6270 E3	142637

Vandal Resistant Stainless Steel SCAWP1/SS 142925
Diffuser Clips. 2 Required Per Foot (2/300mm)

BESA Mounting Brackets (pair) SCAWP2/BESAKIT 144965

For 110 volt weatherproof battens see Site Lighting Page 167, 168



Lighting

IP65 WEATHERPROOF BATTENS WITH POLYCARBONATE DIFFUSER



IP65 WEATHERPROOF BATTENS WITH POLYCARBONATE DIFFUSER

Utilising an injection moulded impact resistant interior stippled polycarbonate diffuser with high light output securely fastened via a gasket to a glass reinforced polyester base.

IP65 Dust Tight and Jet proof for use in harsh environments.

Ideal for underground car parks, stations, garages and open exterior areas.

Top quality internal components ensure a long low maintenance service life.

Integral emergency versions are 3 hour maintained.

Diffuser is retained with plastic latches with the option of stainless steel tamper resistant clips available.

SECTOR



Polycarbonate Weatherproof High Frequency

Integral High Frequency control gear provides instant start with longer lamp life.

Flicker free operation independent of mains voltage fluctuations also provides reliable operation and long service life.

Used in conjunction with Triphosphor tubes up to 20% energy saving can be achieved.

Single: W 115mm x H 105mm. Twin: W 185mm x H 105mm.

Requires T8 Fluorescent tube.

Length	Size	Lamp	Ref No.	Order No.
				0001

Single High Frequency

4Ft	1.2m	1 x 36W	SWP4136HF	142695
5Ft	1.5m	1 x 58W	SWP5158HF	142734
6Ft	1.8m	1 x 70W	SWP6170HF	142776

Single High Frequency Emergency - Maintained

4Ft	1.2m	1 x 36W	SWP4136HF E3	142705
5Ft	1.5m	1 x 58W	SWP5158HF E3	142747
6Ft	1.8m	1 x 70W	SWP6170HF E3	142789

Twin High Frequency

4Ft	1.2m	2 x 36W	SWP4236HF	142828
5Ft	1.5m	2 x 58W	SWP5258HF	142860
6Ft	1.8m	2 x 70W	SWP6270HF	142909

Twin High Frequency Emergency - Maintained

4Ft	1.2m	2 x 36W	SWP4236HF E3	142831
5Ft	1.5m	2 x 58W	SWP5258HF E3	142873
6Ft	1.8m	2 x 70W	SWP6270HF E3	142912

Vandal Resistant Stainless Steel SCAWP1/SS 142925
Diffuser Clips. 2 Required Per Foot (2/300mm)

SECTOR



Polycarbonate Weatherproof Switch Start

Integral switch start High power factor control gear

Single: W 115mm x H 105mm. Twin: W 185mm x H 105mm.

Require a single T8 Fluorescent tube.

Length	Size	Lamp	Ref No.	Order No.
				0001

Single Switch Start

2Ft	0.6m	1 x 18W	SWP2118	142666
4Ft	1.2m	1 x 36W	SWP4136	142679
5Ft	1.5m	1 x 58W	SWP5158	142718
6Ft	1.8m	1 x 70W	SWP6170	142750

Single Switch Start Emergency - Maintained

4Ft	1.2m	1 x 36W	SWP4136 E3	142682
5Ft	1.5m	1 x 58W	SWP5158 E3	142721
6Ft	1.8m	1 x 70W	SWP6170 E3	142763

Twin Switch Start

2Ft	0.6m	2 x 18W	SWP2218	142792
4Ft	1.2m	2 x 36W	SWP4236	142802
5Ft	1.5m	2 x 58W	SWP5258	142844
6Ft	1.8m	2 x 70W	SWP6270	142886

Twin Switch Start Emergency - Maintained

4Ft	1.2m	2 x 36W	SWP4236 E3	142815
5Ft	1.5m	2 x 58W	SWP5258 E3	142857
6Ft	1.8m	2 x 70W	SWP6270 E3	142899

Vandal Resistant Stainless Steel SCAWP1/SS 142925
Diffuser Clips. 2 Required Per Foot (2/300mm)

BESA Mounting Brackets (pair) SCAWP2/BESAKIT 144965

SECTOR Plus

Lighting

DISCHARGE LOWBAYS & HIGHBAYS



INDUSTRIAL DISCHARGE DOWNLIGHTS

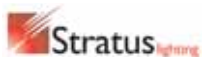

Discharge Lowbay Luminaire

Includes high output and efficient discharge lamps.
 Pressed Steel body with many fixing points.
 Hammer finish aluminium reflector for increased light distribution and efficiency.
 Easy installation with hinged lamp/geartray.
 Ideal for Warehouse, storeroom, retail or factory ceilings below 6m.

Watts	Type	Lamp	Ref No.	Order No. 5544
Low Pressure Sodium				
250W	Son	GES	IND3702	330493
400W	Son	GES	IND3703	330503

Quartz Metal Halide - With Glass

250W	Halide	GES	IND3704	330516
400W	Halide	GES	IND3705	330529

Accessories

Polycarbonate Lowbay Cover	IND3700/PC	330891
----------------------------	------------	--------



Discharge HighBay Luminaire

Includes high output and efficient discharge lamps.

Ordered as two components:

1. Durable Anodised Aluminium reflector.
 2. Gear housing with galvanised geartray lamp holder and lamp.
- Ideal for Warehouse, storeroom, retail or factory ceilings above 5m.
 Decorative Acrylic diffuser, lower wattage versions available.

Watts	Type	Lamp	Ref No.	Order No. 5544
-------	------	------	---------	----------------

All HighBays require a reflector

Highbay Aluminium Spun Reflector	IND-HBSR	010852
----------------------------------	----------	--------

Mercury Discharge Housing & Lamp

250W	MBFU	GES	IND-HBM250SRL	010836
400W	MBFU	GES	IND-HBM400SRL	010849

Low Pressure Sodium Housing & Lamp

250W	Son	GES	IND-HBS250SRL	010797
400W	Son	GES	IND-HBS400SRL	010807

Quartz Metal Halide Housing & Lamp

250W	Halide	GES	IND-HBH250SRL	010810
400W	Halide	GES	IND-HBH400SRL	010823

Twin beam emergency lights for use in large open areas see Pages 84, 85

Lighting

FLUORESCENT BATTENS



T8 FLUORESCENT BATTENS

A comprehensive range of Fluorescent Battens and Accessories to ensure the light from the single or twin tubes is effective in residential through to commercial and Industrial applications.

High quality powder coated paint finish with smooth edges. Integral emergency versions are 3 hour maintained.

Fluorescent tubes Included white colour 35 in Switch Start and Triphosphor colour 840 in High Frequency. Colour matched injection moulded end caps with alignment pins for continuous mounting.

SECTOR



Sectorpack II High Frequency Battens

Integral High Frequency control gear provides instant start with longer lamp life and energy savings of up to 20%.

Also High Energy and Efficiency T5 lamp options.

Flicker free operation independent of mains voltage fluctuations also provides reliable operation and long service life.

Includes Fluorescent tubes Triphosphor colour 840.

Length	Size	Lamp	Ref No.	Order No.
				0001

Single High Frequency

4Ft	1.2m	1 x 36WT8	SBF4136HF	142970
5Ft	1.2m	1 x 35WT5	SBF5135T5	143474
5Ft	1.5m	1 x 49WT5	SBF5149T5	143487
5Ft	1.5m	1 x 58WT8	SBF5158HF	143021
6Ft	1.8m	1 x 70WT8	SBF6170HF	143076

Single High Frequency Emergency - Maintained

4Ft	1.2m	1 x 36WT8	SBF4136HF E3	142983
5Ft	1.5m	1 x 58WT8	SBF5158HF E3	143034
6Ft	1.8m	1 x 70WT8	SBF6170HF E3	143089

Twin High Frequency

4Ft	1.2m	2 x 36WT8	SBF4236HF	143160
5Ft	1.5m	2 x 58WT8	SBF5258HF	143212
6Ft	1.8m	2 x 70WT8	SBF6270HF	143267

Twin High Frequency Emergency - Maintained

4Ft	1.2m	2 x 36WT8	SBF4236HF E3	143173
5Ft	1.5m	2 x 58WT8	SBF5258HF E3	143225
6Ft	1.8m	2 x 70WT8	SBF6270HF E3	143270

SECTOR

Sectorpack II Single Switch Start Battens

Integral switch start high power factor control gear.

Include a single T8 Fluorescent tube (T12 8Ft).

Length	Size	Lamp	Ref No.	Order No.
				0001

Switch Start

2Ft	0.6m	1 x 18W	SBF2118	142938
4Ft	1.2m	1 x 36W	SBF4136	142954
5Ft	1.5m	1 x 58W	SBF5158	143005
6Ft	1.8m	1 x 70W	SBF6170	143050
8Ft	2.4m	1 x 100W	SBF81100	143102

Switch Start Emergency - Maintained

4Ft	1.2m	1 x 36W	SBF4136 E3	142967
5Ft	1.5m	1 x 58W	SBF5158 E3	143018
6Ft	1.8m	1 x 70W	SBF6170 E3	143063

SECTOR

Sectorpack II Twin Switch Start Battens

Integral switch start high power factor control gear.

Includes two T8 Fluorescent tubes (8 Ft T12).

Length	Size	Lamp	Ref No.	Order No.
				0001

Switch Start

2Ft	0.6m	2 x 18W	SBF2218	143128
4Ft	1.2m	2 x 36W	SBF4236	143144
5Ft	1.5m	2 x 58W	SBF5258	143199
6Ft	1.8m	2 x 70W	SBF6270	143241
8Ft	2.4m	2 x 100W	SBF82100	143296

Switch Start Emergency - Maintained

4Ft	1.2m	2 x 36W	SBF4236 E3	143157
5Ft	1.5m	2 x 58W	SBF5258 E3	143209
6Ft	1.8m	2 x 70W	SBF6270 E3	143254

The New Sectorpack II features the latest in Lamp and Gear technology.

- 5ft T5 49W HF battens have similar lumen output to a 58W batten = 15% energy saving.
- 5ft T5 35W HF battens have similar light output to a 4ft 36W batten = 20% less fittings required.

SECTOR *plus*

Lighting

FLUORESCENT BATTEN ACCESSORIES

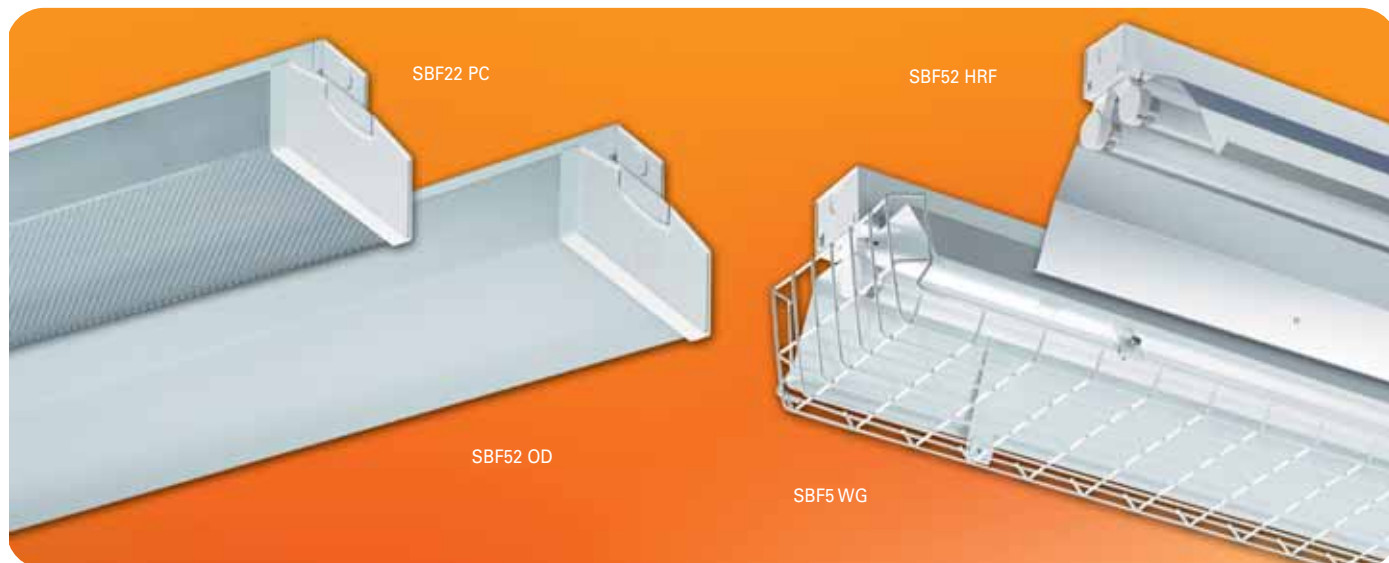

SECTOR

Sectorpack II Prismatic Controllers

A clear styrene prismatic controller with fast fit plastic end caps that attach to batten, both T8 and T5 versions.

Prismatic controllers disguise the lamps while maintaining an efficient and general light distribution.

Length	Size	Finish	Ref No.	Order No.
				0001

Single 77mm Wide

2Ft	0.6m	Prismatic	SBF21 PC	142941
4Ft	1.2m	Prismatic	SBF41 PC	142996
5Ft	1.5m	Prismatic	SBF51 PC	143047
6Ft	1.8m	Prismatic	SBF61 PC	143092
8Ft	2.4m	Prismatic	SBF81 PC	143115

Twin 160mm Wide

2Ft	0.6m	Prismatic	SBF22 PC	143131
4Ft	1.2m	Prismatic	SBF42 PC	143186
5Ft	1.5m	Prismatic	SBF52 PC	143238
6Ft	1.8m	Prismatic	SBF62 PC	143283
8Ft	2.4m	Prismatic	SBF82 PC	143306

SECTOR

Sectorpack II Opal Diffusers

An opal styrene diffuser with fast fit plastic end caps that attach to the batten both T8 and T5 versions.

Opal diffusers disguise the lamps to a greater extent than prismatic. Lower glare is therefore more suitable for domestic and public area use as well as a softer light when combined with other sources.

Length	Size	Finish	Ref No.	Order No.
				0001

Single 77mm Wide

5Ft	1.5m	Opal	SBF51 OD	143351
6Ft	1.8m	Opal	SBF61 OD	143364

Twin 160mm Wide

5Ft	1.5m	Opal	SBF52 OD	143377
6Ft	1.8m	Opal	SBF62 OD	143380

SECTOR

Sectorpack II Steel Reflectors and Wire Guards

Suitable for single and twin T8 Sectorpack Battens.

Steel reflectors that attach to the gear tray cover behind the lamp providing a wide distribution of light ideal for storage and factory areas.

White steel wire cages to be mounted on a standard reflector using 2 supplied zintec brackets.

Provides physical protection to tube ideal in areas such as sports halls and factories.

Angled reflectors enable specific wall or task lighting.

Length	Size	Fitting	Ref No.	Order No.
				0001

Single & Twin Reflector 195mm Wide

4Ft	1.2m	Single & Twin	SBF4 RF	143319
5Ft	1.5m	Single & Twin	SBF5 RF	143322
6Ft	1.8m	Single & Twin	SBF6 RF	143335
8Ft	2.4m	Single & Twin	SBF8 RF	143348

Wire Guards (Require Steel Reflector)

5Ft	1.5m	Single & Twin	SBF5 WG	143458
6Ft	1.8m	Single & Twin	SBF6 WG	143461

White Angled Reflectors

5Ft	1.5m	Single & Twin	SBF5 ARF	143393
6Ft	1.8m	Single & Twin	SBF6 ARF	143403

SECTOR

Sectorpack II High Rack Reflector

High rack quality polished aluminium reflector projects a narrow beam of concentrated light enabling the batten designed specifically for racking aisles.

Suitable for single and twin T8 SectorPack Battens.

Length	Size	Lamp	Ref No.	Order No.
				0001

5Ft	1.5m	Single	SBF51 HRF	143416
6Ft	1.8m	Single	SBF61 HRF	143429

5Ft	1.5m	Twin	SBF52 HRF	143432
6Ft	1.8m	Twin	SBF62 HRF	143445

Lighting

T8 & SEALED T8 FLUORESCENT BATTENS & DIFFUSERS

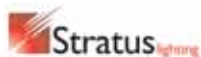

Single High Frequency Fluorescent Battens

A top end Batten with High frequency gear as standard primarily designed for illuminating commercial, Leisure and warehouse space.

Top quality internal components ensure a long low maintenance service life.

Includes a single T8 Fluorescent white colour 35.

Length	Size	Lamp	Ref No.	Order No.
				5544

High Frequency

5Ft	1.5m	1 x 58W	BTN158HF	008372
6Ft	1.8m	1 x 70W	BTN170HF	008398

High Frequency Emergency - Maintained

5Ft	1.5m	1 x 58W	BTN158HFE3	008437
6Ft	1.8m	1 x 70W	BTN170HFE3	008453

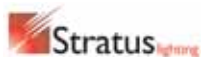

Twin High Frequency Fluorescent Battens

Integral High frequency gear as standard.

Integral emergency control gear is 3 hour maintained.

Includes two T8 Fluorescent tubes white colour 35.

Length	Size	Lamp	Ref No.	Order No.
				5544

High Frequency

5Ft	1.5m	2 x 58W	BTN258HF	008385
6Ft	1.8m	2 x 70W	BTN270HF	008408

High Frequency Emergency - Maintained

5Ft	1.5m	2 x 58W	BTN258HFE3	008440
6Ft	1.8m	2 x 70W	BTN270HFE3	008466



Academy HF Sealed Batten

A robust, fully sealed luminaire for use in clean area environments.

An upmarket batten ideal for use in general areas where tampering or vandalism may occur.

Secured and fully enclosed, therefore ideal for use in areas such as offices, corridors, toilets, stores, classrooms, lecture halls etc.

High Frequency as standard, further body, lamp and diffuser options available.

Requires T8 Fluorescent tubes.

Length	Size	Lamp	Ref No.	Order No.
				5544

Single HFTP(b) Diffuser

5Ft	1.5m	1 x 58W	ACA158HFTPb	009119
6Ft	1.8m	1 x 70W	ACA170HFTPb	009122

Twin HFTP(b) Diffuser

5Ft	1.5m	2 x 58W	ACA258HFTPb	009148
6Ft	1.8m	2 x 70W	ACA270HFTPb	009151

Lighting

MINI FLUORESCENT BATTENS



T5 & T8 Fluorescent Linklights

Very Slim switch start mini battens 90mm depth x 40mm wide.

Batten can be mounted on both planes.

Integrated on/off switch and a link plug and socket.

Integral switch start ballast for long trouble free reliable operation.

Ideal for commercial, domestic, residential and retail applications.

Link leads, blanks and self wire plugs are available separately.

Includes Fluorescent Tubes white colour 35.

Lamp	Type	Length (mm)	Ref No.	Order No. 0001
------	------	-------------	---------	----------------

T5 Fluorescent

6W	T5	243	SMFT56L	122961
8W	T5	320	SMFT58L	122974
13W	T5	548	SMFT513L	122987

T8 Fluorescent

15W	T8	473	SMFT815L	122990
16W	T8	755	SMFT816L	124532
18W	T8	625	SMFT818L	123009
30W	T8	930	SMFT830L	123012
36W	T8	1230	SMFT836L	123025
58W	T8	1560	SMFT858L	123038

Link Light Accessories

T5/T8	Male / Female	Plugs	SMF/PMF	123070
T5/T8	Straight	Butt Connector	SMF/SC	126666
T5/T8	Male / Female	Blank Plugs	SMF/BPMF	123054
T5/T8	Connector	1000	SMF/CL1000	123041
T5/T8	Connector	500	SMF/CL500	123083
T5/T8	Mains Lead	1500	SMF/ML1500	123067



T4 HF Fluorescent Linklights

Tiny High frequency mini battens 43mm depth x 20mm wide.

Switched batten includes tube, universal mounting brackets and mains 2M connection lead with plug.

Includes Triphosphor Fluorescent Tubes colour 827.

Ideal under kitchen cabinets and incorporated into furniture and fitments.

Lamp	Type	Length (mm)	Ref No.	Order No. 0001
------	------	-------------	---------	----------------

HF Linklights with 2M mains lead

6W	T4	275	SMFT46L	122851
8W	T4	400	SMFT48L	122864
16W	T4	530	SMFT416L	122877
20W	T4	630	SMFT420L	123122
30W	T4	815	SMFT430L	122880

Link Leads

2 Wired Plugs & Flex	250	SMFLL250	122893
3 Wired Plugs & Flex	500	SMFLL500	122903

Spare T4 Fluorescent Tubes Colour 827

6W	T4	205	SMFL6W827	122916
8W	T4	330	SMFL8W827	122929
16W	T4	440	SMFL16W827	122932
20W	T4	550	SMFL20W827	123945
30W	T4	750	SMFL30W827	122958



T5 HF Fluorescent Linklights

Mini Battens including a standard T5 fluorescent tube colour 830.

Shallow cross section of 23mm x 40mm with integral switch.

Includes ribbed diffuser, mains lead, butt connector and flexible corner.

Lamp	Type	Length (mm)	Ref No.	Order No. 0001
------	------	-------------	---------	----------------

T5 HF Linklights with 2M mains lead

6W	T5	275	SHF6WT5L9	145870
8W	T5	355	SHF8WT5L12	145883
14W	T5	595	SHF14WT5L2	145896
21W	T5	900	SHF21WT5L3	145906
28W	T5	1215	SHF28WT5L4	145919



Lighting

SURFACE DISPLAY & ACCENT LIGHTING



SURFACE LIGHTING: SURFACE DISPLAY & ACCENT LIGHTING



Single Circuit Mains Track

Slim profile suitable for wall or ceiling mounting.

Includes a live-end, a dead-end and mounting clips and an electrical coupling kit to join tracks together.

Rated at 16A but may be restricted by the circuit rating.

Length	Volts	Amps	Finish	Ref No.	Order No.
					0001

White 240V Starter Track

1m	240V	16A	White	S10861M WHI	125447
2m	240V	16A	White	S10862M WHI	125463

Silver 240V Starter Track

1m	240V	16A	Silver	S10861M SILV	125450
2m	240V	16A	Silver	S10862M SILV	125476

Sector and Stratus track systems are compatible with the following single circuit mains track light systems: Concord Lightspan 1(L1), Luminance Nanotrack, Hacel, Global track (G1), Reggiani 22 range, Firstlight Easytrack, Powerlite Global (S), Thorn Mastertrack.



Mains Track Mounted Fittings

Available in four sizes to suit variety of applications they can accept mains voltage ES Halogen Par lamps as well as standard ES reflector lamps.

360° rotation and 90° vertical tilt.

Require Lamps.

Lamp	Cap	Type	Finish	Ref No.	Order No.
					0001

White 240V Track Mounted

50W	GU10	50mm Par 16	White	S37250 WHI	125489
60W	ES	R64 / Par 20	White	S37000 WHI	992829
100W	ES	R80 / Par 25	White	S37050 WHI	993462
100W	ES	R95 / Par 30	White	S37100 WHI	993475

Silver 240V Track Mounted

50W	GU10	50mm Par 16	Silver	S37250 SILV	125492
60W	ES	R64 / Par 20	Silver	S37000 SILV	125502
100W	ES	R80 / Par 25	Silver	S37050 SILV	125515
100W	ES	R95 / Par 30	Silver	S37100 SILV	125528



Low Voltage Mains Track Mounted Fittings

Mains track mounted low voltage dichroic spotlight with integral transformer.

Compatible with Sector and many other types of Global compatible Lighting track.

Surface mount and black options also available.

Requires Lamps.

Lamp	Cap	Type	Finish	Ref No.	Order No.
					5544

Flite

50W	12V 50mm	Dichroic	White	LVP4150 WHI	440859
50W	12V 50mm	Dichroic	Silver	LVP4150 ALU	021692



Lighting

SURFACE DISPLAY & ACCENT LIGHTING

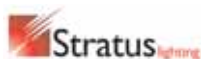

Mezzo

Lamp	Cap	Type	Finish	Ref No.	Order No. 5544
50W	12V 50mm	Dichroic	White	LVP4601 WHI	440493
50W	12V 50mm	Dichroic	Silver	LVP4601 ALU	019950

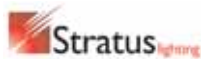

Discharge Mains Track Mounted Fittings

Compatible with Sector and many other types of Global compatible lighting track.

These fittings provide a powerful controllable light source.

Ideal for retail and display lighting.

Surface mount and Silver or Black options also available.

Includes colour 830 TC Ceramic Metal Halide capsule lamp.

Lamp	Cap	Type	Finish	Ref No.	Order No. 5544
35W	CDM-TC	Ceramic Halide	White	MHPT8035TC WHI	026422
70W	CDM-TC	Ceramic Halide	White	MHPT8070TC WHI	026435

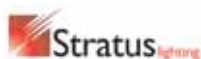

Projector

Requires double ended Metal halide lamp ceramic or quartz.

Lamp	Cap	Type	Finish	Ref No.	Order No. 5544
70W	RX7	Halide	White	MHPT9070 WHI	018210
150W	RX7	Halide	White	MHPT9150 WHI	018278
250W	RX7	Halide	White	MHPT9250 WHI	018333



Low Voltage Trackpacks

Trackpack includes dimmable electronic transformer, track with mounting brackets and quality fittings with lamps surrounded by an acid glass bezel.

Heads fully adjustable into many positions for precise spotlighting over a large area.

Lamps included.

Lamp	Type	Finish	Ref No.	Order No. 0001
------	------	--------	---------	----------------

150VA 1 Metre 3 Fittings

3 x 50W	12V 50mm	White	SLVTK3W2	115680
3 x 50W	12V 50mm	Brass	SLVTK3BR2	115703
3 x 50W	12V 50mm	Chrome	SLVTK3CH2	127694
3 x 50W	12V 50mm	Satin Chrome	SLVTK3SCH2	127704
3 x 50W	12V 50mm	Black	SLVTK3BL2	115693

210VA 2 Metres 4 Fittings

4 x 50W	12V 50mm	White	SLVTK4W2	115716
4 x 50W	12V 50mm	Brass	SLVTK4BR2	115732
4 x 50W	12V 50mm	Chrome	SLVTK4CH2	127717
4 x 50W	12V 50mm	Satin Chrome	SLVTK4SCH2	127720
4 x 50W	12V 50mm	Black	SLVTK4BL2	115729



Low Voltage Wire Kits

Two safety low voltage wire kits for contemporary lighting indoors. 12V power is conducted from the transformer to the lamp via the suspension wire.

The transformer should be mounted remotely hidden on the smaller kit.

The larger kit has a more attractive transformer and cast fittings.

Lamps included.

Lamp	Transformer	Span	Ref No.	Order No. 0001
5x20W 12V	100VA	4.5M	SLV100WIRE	143513
5x35W 12V	175VA	9.5M	SLV175WIRE	143526



Lighting

SURFACE DISPLAY & ACCENT LIGHTING



SECTOR

Low Voltage Spotlights

High quality metal finish fittings with lamp and integral non dimmable transformer.

Heads mounted on adjustable knuckle for precise alignment of powerful halogen light.

Includes Lamps.

Lamp	Type	Finish	Ref No.	Order No.
				0001

Single Bar 50VA Transformer

50W	12V 50mm	White	SLV1SURF WH	125696
50W	12V 50mm	Black	SLV1SURF BLK	125719
50W	12V 50mm	Chrome	SLV1SURF CH	125706

Triple Plate 105VA Transformer

3 x 35W	12V 50mm	White	SLV3PLATE WH	125968
3 x 35W	12V 50mm	Chrome	SLV3PLATE CH	125971

SECTOR

Mains Voltage Spotlights

Powdercoat white cowls on steel with polycarbonate mountings.

Switched single is double insulated.

Requires Lamps.

Lamp	Cap	Description	Ref No.	Order No.
				0001
60W	ES R64	Single Switched	S1SPOTA	111309
2 x 60W	ES R64	Double Bar	S2SPOTA	111312
3 x 60W	ES R64	Triple Plate	S3SPOTA	111325

SECTOR

GU10 Mains Voltage Spotlights

High quality cast zamac head and satin chrome body.

Transformer not required for fully dimmable halogen light.

Switched single is double insulated.

Includes Lamps.

Lamp	Cap	Description	Ref No.	Order No.
				0001
50W	GU10	Single Switched	SGU1SURF SCH	124684
3 x 50W	GU10	Triple Plate	SGU3PLATE SCH	124707
4 x 50W	GU10	Quad Bow	SGU4BOW SCH	125735



Lighting

SURFACE DISPLAY & ACCENT LIGHTING, STRIPLIGHT & SHAVERLIGHTS



SECTOR

Sector Picture Lights

High quality metal finish.
Integral gear and transformer.
Ideal for residential, retail and commercial applications.
Requires Lamps.



Lamp	Type	Finish	Ref No.	Order No. 0001
------	------	--------	---------	----------------

Striplight - 355mm

60W	284mm	Brass	SPIC284 BR	124749
60W	284mm	Satin Chrome	SPIC284 SCH	124752

Low Voltage Includes Transformer - 370mm

2 x 20W	12V M47	Brass	SPICLV1 BR	125382
2 x 20W	12V M47	Chrome	SPICLV1 CH	125395

Low Energy - 355mm

11W	TCS 2 Pin	Brass	SPICPL11 BR	125405
-----	-----------	-------	-------------	--------

SECTOR

IP44 G9 Decorative Wall Lights

Very high quality chrome finish suitable for surface mount in a bathroom.

Bright white light from a tiny halogen light source without the need for transformers.

Includes Lamps.

Lamp	Type	Finish	Ref No.	Order No. 0001
------	------	--------	---------	----------------

Single Lamp - 165mm

1 x 40W	240V G9	Vertical	SBR1VG9 CH	125777
---------	---------	----------	------------	--------

Double Lamp - 224mm

2 x 40W	240V G9	Vertical	SBR2VG9 CH	125780
2 x 40W	240V G9	Horizontal	SBR2HG9 CH	125793

STRIPLIGHT & SHAVERLIGHTS

SECTOR

Striplights

Simple white all polycarbonate construction with opal diffuser.
Lamp holder isolation when diffuser is removed.
Includes Striplight Lamp.

Lamp	Type	Description	Ref No.	Order No. 0001
------	------	-------------	---------	----------------

60W	284mm	Pull cord	STRIPPC	996867
60W	284mm	Unswitched	STRIPUS	996854

SECTOR

Dual Voltage Insulated Shaverlight

Polycarbonate body opal diffuser and pullcord for light.

2 Pin socket switchable between 110V and 240V.

White body, IP44 also available in chrome.

Includes Striplight Lamp or low energy lamp.



Lamp	Type	IP Rating	Ref No.	Order No. 0001
------	------	-----------	---------	----------------

60W	284mm	21	S8001DV	125434
-----	-------	----	---------	--------

SECTOR plus

Lighting

STRIPLIGHT & SHAVERLIGHTS, WALL & CEILING LIGHTING



SECTOR



Steel Shaverlight

White rigid steel body with opal Diffuser and pullcord.
Single 2 pin socket suitable for rechargeable shavers.
IP21 with double wire wound safety transformer.
Includes Lamps.

Lamp	Type	Finish	Ref No.	Order No.
				0001

Striplight

60W	284mm	White Steel	S6000	998030
-----	-------	-------------	-------	--------

Low Energy

11W	TCS 2 Pin	White Steel	S6000LE	125421
-----	-----------	-------------	---------	--------

SECTOR

Globe And Crystal Light

Original opal glass globe with white Polypropylene collar.
Decorative Crystal effect glass ceiling fitting.
Requires Lamps.

Lamp	Type	Diffuser	Ref No.	Order No.
60W	ES	Opal Glass Globe	SGLOBE60	110012
60W	ES	Round Crystal Glass	SCRYRO	111435

SECTOR

Tubular Glass Wall Light

Attractive acid glass wall and ceiling light with metal end caps.
IP40 switched on end caps.
Requires Lamps.

Lamp	Type	Finish	Ref No.	Order No.
				0001

200mm

1 x 40W	SES	Brass	SWL140T BR	125816
1 x 40W	SES	Chrome	SWL140T CH	125829

350mm

2 x 40W	SES	Brass	SWL240T BR	125845
2 x 40W	SES	Chrome	SWL240T CH	125858

WALL & CEILING LIGHTING

SECTOR



Low Energy Mirror Light

High quality low energy IP43 bathroom fitting.
Requires Lamps - See pages 5 - 19.

Lamp	Type	Finish	Length	Ref No.	Order No.
					0001
24W	TCL 4 Pin	Chrome	395mm	SBR24PL CH	124642

Lighting

WALL LIGHTING

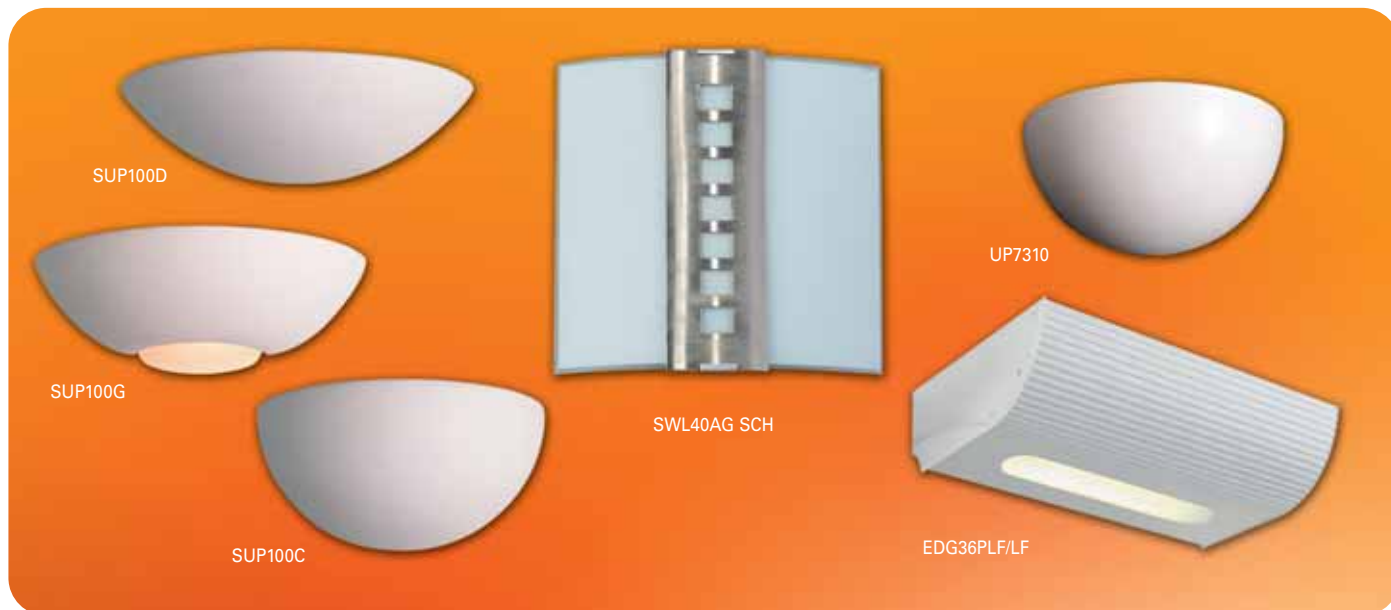

SECTOR

Sector Curved Glass Wall Light

Attractive acid glass decorative wall light 260mm square.

Requires Lamps.

Lamp	Type	Finish	Ref No.	Order No.
60W	ES	Satin Chrome	SWL40AG SCH	125366

SECTOR

Ceramic Uplighters

High Quality unglazed ceramic finish that can be painted.

Requires Lamps.

Lamp	Cap	Description	Length	Ref No.	Order No.
100W	ES	Uplight	250mm	SUP100C	135495
100W	ES	Up/Downlight	300mm	SUP100G	135505
100W	ES	Uplight	330mm	SUP100D	135518
200W	DE Hal	Uplight	330mm	SUP200D	135521

Low Energy

18W	TCD 2 Pin	Uplight	330mm	SUP118D	135534
-----	-----------	---------	-------	---------	--------



Stratus lighting



Midi Dome Uplighters

The Dome quarter sphere uplighters provide a soft friendly ambience with the option of a TCS 5W 4 Pin backlit lamp source providing a floating effect as well as instant light during the warm up time of halide lamp sources.

Width: 420mm - spun aluminium construction.

Requires Lamps.

Lamp	Cap	Finish	Ref No.	Order No.
				5544

Direct Fix To Wall

32W	TCTE 4 Pin	White	UP7310	017101
42W	TCTE 4 Pin	White	UP7311	017114
70W	RX7 Halide	White	UP7107	770228
150W	RX7 Halide	White	UP7108	770231

Stand Off The Wall Backlit With Auxiliary Lamp

32W	TCTE 4 Pin	White	UP7123	032270
42W	TCTE 4 Pin	White	UP7124	032283
70W	RX7 Halide	White	UP7109	770244
150W	RX7 Halide	White	UP7110	770257

Stratus lighting



Edge Uplighters

High quality Indirect wall mounted luminaire producing excellent upward light quality with decorative downward light feature.

Extruded aluminium construction powder coated white with HF gear.

Requires Lamps.

Lamp	Cap	Control Gear	Ref No.	Order No.
				5544

Mini Edge Length 275mm - White

36W	TCF 4 Pin	High Frequency	EDG36PLF/LF	017871
36W	TCF 4 Pin	HF Emergency	EDG36PLF/LF/EM	017884

Maxi Edge Length 570mm - White

2x55W	TCL 4 Pin	High Frequency	EDG255PL/LF	017693
2x55W	TCL 4 Pin	HF Emergency	EDG255PL/LF/EM	017703

SECTOR plus

Lighting

WALL & CEILING LIGHTING



Decorflush Wall and Ceiling Luminaires

Slim line design metal ceiling luminaires with attractive opal glass. Emergency versions are integral 3 hour maintained. Requires Lamps.

Lamp	Cap	Finish	Ref No.	Order No.
				0001

Decorflush Circular GLS / ES CFL - 300mm

60W	ES	White	SDECO60W	110025
60W	ES	Brass	SDECO60B	113022
60W	ES	Chrome	SDECO60C	113035

Low Energy - 300mm

16W	2D 2 Pin	White	SDECO16W	110038
16W	2D 2 Pin	Brass	SDECO16B	113048
16W	2D 2 Pin	Chrome	SDECO16C	113051

Low Energy - 370mm

28W	2D 4 Pin	White	SDECO28W	113064
28W	2D 4 Pin	Brass	SDECO28B	113077
28W	2D 4 Pin	Chrome	SDECO28C	113080

Emergency Low Energy - 370mm

21W	2D 4 Pin	White	SDECO21W/E3	143555
21W	2D 4 Pin	Brass	SDECO21B/E3	143568
21W	2D 4 Pin	Chrome	SDECO21C/E3	143571

Decorflush Half Wall Light GLS / ES CFL - 310mm

60W	ES	White	SDEHO60W	125900
60W	ES	Brass	SDEHO60B	125913
60W	ES	Chrome	SDEHO60C	125926

Low Energy - 310mm

13W	TCD 2 Pin	White	SDEHO13W	125939
13W	TCD 2 Pin	Brass	SDEHO13B	125942
13W	TCD 2 Pin	Chrome	SDEHO13C	125955



IP44 Steel Wall and Ceiling Lights

Attractive Slim Profile Polished Steel with domed Acid glass. Ideal for wall or ceiling mount especially in bathrooms. Requires Lamps.

Lamp	Cap	Diameter	Ref No.	Order No.
				0001

240V Halogen Capsule - Chrome

40W	240V G9	180mm	SBR180C CH	125748
-----	---------	-------	------------	--------

GLS / ES CFL - Chrome

60W	ES	320mm	SBR320C CH	135482
-----	----	-------	------------	--------

Low Energy - Chrome

1 x 9W	TCS 2 Pin	310mm	SBR310C CH	125751
2 x 9W	TCS 2 Pin	400mm	SBR400C CH	125764



IP44 Polycarb Wall and Ceiling Lights

Tough polycarbonate base with attractive domed acid glass diffuser. Ideal for wall and ceiling mount especially in bathrooms. Easy lamp change with first fix base and twist on bezel and glass. Requires lamps.

Lamp	Cap	Diameter	Ref No.	Order No.
				0001

GLS / ES CFL - White

60W	ES	255mm	SBR255W	143542
-----	----	-------	---------	--------

Low Energy White

13W	TCD 2 Pin	255mm	SBR255LEW	143539
-----	-----------	-------	-----------	--------

Lighting

DECORATIVE BULKHEADS



Squarelite Wall and Ceiling Luminaire

IP20 white polycarbonate body with low profile of only 90mm.

Easy to install with quick-fit gear tray and snap on diffuser.

Integral 3 Hour maintained emergency gear option.

White base, opal diffuser. Includes lamp.

Lamps	Diameter	Ref No.	Order No. 8274
28W 2D 4 Pin	260mm	EL-JSQ28/2D	114452
28W 2D 4 Pin, Emergency	260mm	EL-JSQ28/3M	114465



Circulite Wall and Ceiling Luminaire

IP20 white polycarbonate body with low profile of only 100mm.

Easy to install with quick-fit gear tray and snap on diffuser.

Integral 3 Hour maintained emergency gear option.

White base, opal diffuser. Includes lamp.

Lamps	Diameter	Ref No.	Order No. 8274
16W 2D 4 Pin	285mm	EL-JCL16/2D	114410
28W 2D 4 Pin	285mm	EL-JCL28/2D	894921
16W 2D 4 Pin, Emergency	285mm	EL-JCL16/3M	114423
28W 2D 4 Pin, Emergency	285mm	EL-JCL28/3M	894918



Cooline Wall and Ceiling Luminaire

A quality spun aluminium base and easy fix flip polycarbonate diffuser.

The Cooline range is designed to run the high output 2D lamp at low temperatures, creating maximum light output from the smallest body size, allowing 3 hour integral emergency backup housed in an attractive luminaire.

Ideal for hotels, receptions, corridors, and waiting areas and especially suited to surface mounting on stairwells.

At 108mm the cooline range is slim, this can be further reduced by semi-recessing into a ceiling with the optional kit.

Many further body, diffuser and gear options are available to order.

White base, opal diffuser. Includes GE T5 2D 4 Pin lamps (16W 2 pin).

Lamps	Diameter	Ref No.	Order No. 5544
-------	----------	---------	-------------------

Minor Switch Start

16W 2D	260mm	UT-16250WO	004923
--------	-------	------------	--------

Mini Switch Start

16W 2D	355mm	UT-16350WO	004965
16W 2D, Emergency	355mm	UT-16350WO E3	005045
28W 2D	355mm	UT-28350WO	005139

Mini High Frequency

28W 2D	355mm	UT-28350WO HF	006235
28W 2D, Emergency	355mm	UT-28350WO HFE3	006277

Midi Switch Start

28W 2D	432mm	UT-28425WO	005171
28W 2D, Emergency	432mm	UT-28425WO E3	005061
38W 2D	432mm	UT-38425WO	005249
38W 2D, Emergency	432mm	UT-38425WO E3	006251

Midi High Frequency

28W 2D	432mm	UT-28425WO HF	005100
28W 2D, Emergency	432mm	UT-28425WO HFE3	005896
38W 2D	432mm	UT-38425WO HF	010056
38W 2D, Emergency	432mm	UT-38425WO HFE3	005922

Maxi Switch Start

38W 2D	532mm	UT-38525WO	005281
38W 2D, Emergency	532mm	UT-38525WO E3	005362
Cooline Semi-Recessing Kit	UT-RECKIT		006073

Lighting

DECORATIVE BULKHEADS, IP44 & IP54 BULKHEADS

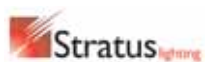

Cooline Halo Wall and Ceiling Luminaire

A resilient and attractive luminaire provided by the all polycarbonate construction and backlit halo effect from the included low energy GE 2DT5 lamp.

Many further body, diffuser and gear options are available to order.

Emergency versions are integral 3 hour maintained.

White base, opal diffuser, Includes GE 2D 4 Pin lamps.

Lamps	Diameter	Ref No.	Order No. 5544
28W 2D	450mm	UT-HALO28450WO	008107
28W 2D	450mm	UT-HALO28450WO HF	008136
28W 2D, Emergency	450mm	UT-HALO28450WO HFE3	008165



IP44 Deco Dome Luminaire

Polycarbonate Base with Gasket and Twist on diffuser.

Other coloured base and prismatic diffuser options available to order.

Emergency versions are integral 3 hour maintained.

White base, opal diffuser.

Low Energy includes 2D 4 Pin lamps (16W 2 pin). GLS version requires lamps.

Lamps	Diameter	Ref No.	Order No. 0001
-------	----------	---------	----------------

GLS / BC CFL

100W BC	314mm	SDD100WO	111451
---------	-------	----------	--------

Low Energy Switch Start

16W 2D	314mm	SDD16WO	111464
28W 2D	388mm	SDD28WO	111477
28W 2D, Emergency	388mm	SDD28HFWO E3	129401



Solar IP54 Deco Luminaire

Attractive and slim (115mm) luminaire for use in semi protected locations with many mounting options.

High specification all polycarbonate construction with easy twist on diffuser.

Easy to install with quick-fit gear tray and diffuser.

Optional kits include bevelled edge surface mounting ring and semi recessing kit for attractive wall or ceiling mount.

Emergency versions are integral 3 hour maintained.

White base, opal diffuser.

Includes lamps.

Lamps	Diameter	Ref No.	Order No. 8274
16W 2D 4 Pin	360mm	EL-VSR16/230	110773
16W 2D 4 Pin, Emergency	360mm	EL-VSR16/3M	110744
28W 2D 4 Pin	360mm	EL-VSR28/230	110786
28W 2D 4 Pin, Emergency	360mm	EL-VSR28/3M	110757
38W 2D 4 Pin	360mm	EL-VSR38/230	110799
Solar Semi Recessing Kit		EL-VSR/RECKIT	110809
Solar Surface Deco Ring (Optional)		EL-VSR/RING	110812

Lighting

IP44 & IP65 BULKHEADS



SQU100/44

SC100/44

UT-IPL100BKO



IP44 Mini Circular / Midi Square Bulkheads

Polycarbonate Base and snap on diffuser.

220mm Dia. 90mm Height.

GLS version requires lamps.

Low Energy Mini Circular version includes 16W 2D 2 Pin Lamps.

Low Energy Midi Square version includes 2D 4 Pin lamps (16W 2 pin).

Lamps	Base	Diffuser	Ref No.	Order No. 0001
-------	------	----------	---------	----------------

GLS / BC CFL - Mini Circular

100W BC	Black	Opal	SC100/44	994225
100W BC	Black	Prismatic	SC100P/44	994241
100W BC	White	Opal	SC100W/44	995017
100W BC	White	Prismatic	SC100PW/44	995088

GLS / BC CFL - Midi Square

100W BC	Black	Opal	SQU100/44	995389
100W BC	Black	Prismatic	SQU100P/44	995392
100W BC	White	Opal	SQU100W/44	114979
100W BC	White	Prismatic	SQU100PW/44	128156

Low Energy Switch Start - Mini Circular

16W 2D	Black	Opal	SC16LE/44	994186
16W 2D	Black	Prismatic	SC16LEP/44	994209
16W 2D	White	Opal	SC16LEW/44	995279
16W 2D	White	Prismatic	SC16LEPW/44	995266

Low Energy Switch Start - Midi Square

16W 2D	Black	Opal	SQU16LE/44	992133
16W 2D	Black	Prismatic	SQU16LEP/44	994144
16W 2D	White	Opal	SQU16LEW/44	995237
16W 2D	White	Prismatic	SQU16LEPW/44	995101
28W 2D	Black	Opal	SQU28LE/44	994131
28W 2D	Black	Prismatic	SQU28LEP/44	994157
28W 2D	White	Opal	SQU28LEW/44	995253
28W 2D	White	Prismatic	SQU28LEPW/44	995240



Cooline IP65 Circular Utility

Designed in an all polycarbonate construction with screw down bezel retaining diffuser.

Louvered eyelid version reduces upward glare.

Emergency version are integral 3 hour maintained.

GLS version requires lamps.

Black base, opal diffuser (other colours available to order).

Includes GE T5 28W 2D 4 Pin lamps (16W 2 Pin).

Lamps	Control Gear	Diameter	Ref No.	Order No. 5544
-------	--------------	----------	---------	----------------

Mini cooline IP65 - Louvre Bezel

100W BC		275mm	UT-IPL100BKO	032319
16W 2D	Switch Start	275mm	UT-IPL16275BKO	032322

Cooline IP65 - Louvre Bezel

28W 2D	Switch Start	350mm	UT-IPL28350BKO	021870
28W 2D	HF Emergency	350mm	UT-IPL28350BKOHF3	021896

Cooline IP65 - Plain Bezel

28W 2D	Switch Start	350mm	UT-IPB28350BKO	021964
28W 2D	HF Emergency	350mm	UT-IPB28350BKOHF3	021980

Lighting

IP65 POLYCARBONATE BULKHEADS



Suitable for Corridors, Washrooms and Exterior building Perimeters and Canopies.
 Bright White Steel gear tray with tool free fixing to base.
 Emergency versions are Integral 3 Hour Maintained.
 Easy wire with rear Besa entry and 25mm round conduit entries in sides.
 Easy wire in Integral Daylight off Operated Photocell option (Not Maxi).



IP65 Square Black / White Opal Bulkheads

Black / White Polycarbonate Base with ready fixed gasket and attractive screw on Opal diffuser.

Includes 2D Lamp.

Lamps	Square x Depth (mm)	Base Colour	Ref No.	Order No. 0001
-------	---------------------	-------------	---------	----------------

Switch Start Midi

28W 2D	260 x 98	Black	SQ28BO	143791
28W 2D	260 x 98	White	SQ28WO	143814

Emergency High Frequency Midi

28W 2D 4 Pin	260 x 98	Black	SQ28BOHF/E3	143830
28W 2D 4 Pin	260 x 98	White	SQ28WOHF/E3	143856

Photocell Option

Internal Mounted Easy Wire Photocell			SCQ1/PCELL	143872
--------------------------------------	--	--	------------	--------



IP65 Circular Black / White Opal Bulkheads

Black / White Polycarbonate Base with ready fixed gasket and attractive circular screw on Opal diffuser.

Includes 2D Lamp.

Lamps	Dia. x Depth (mm)	Base Colour	Ref No.	Order No. 0001
-------	-------------------	-------------	---------	----------------

Switch Start Mini

16W 2D 2Pin	230 x 98	Black	SC16BO	143597
16W 2D 2Pin	230 x 98	White	SC16WO	143610

Switch Start Midi

28W 2D	300 x 98	Black	SC28BO	143636
28W 2D	300 x 98	White	SC28WO	143652
38W 2D 4Pin	300 x 98	Black	SC38BO	143759
38W 2D 4Pin	300 x 98	White	SC38WO	143775

High Frequency Midi

28W 2D 4Pin	300 x 98	Black	SC28BOHF	143678
28W 2D 4Pin	300 x 98	White	SC28WOHF	143694

Emergency High Frequency Midi

28W 2D 4Pin	300 x 98	Black	SC28BOHF/E3	143717
28W 2D 4Pin	300 x 98	White	SC28WOHF/E3	143733

Photocell Option

Internal Mounted Easy Wire Photocell			SCQ1/PCELL	143872
--------------------------------------	--	--	------------	--------

Switch Start Maxi

38W 2D 4Pin	360 x 100	Black	SCM38LE	129058
38W 2D 4Pin	360 x 100	White	SCM38LEW	129074

Emergency High Frequency Maxi

38W 2D 4Pin	360 x 100	Black	SCM38HFLE/E3	129171
38W 2D 4Pin	360 x 100	White	SCM38HFLEW/E3	129197



Lighting

IP65 POLYCARBONATE BULKHEADS



Suitable for Corridors, Washrooms and Exterior building Perimeters and Canopies.
 Bright White Steel gear tray with tool free fixing to base.
 Emergency versions are Integral 3 Hour Maintained.
 Easy wire with rear Besa entry and 25mm round conduit entries in sides.
 Easy wire in Integral Daylight off Operated Photocell option (Not Maxi).



IP65 Circular Black / White Prismatic Bulkheads

Black / White Polycarbonate Base with ready fixed gasket and High Output circular screw on Clear Prismatic diffuser.
 Emergency versions are Integral 3 Hour Maintained.
 Includes 2D Lamp.



IP65 Square Black / White Prismatic Bulkheads

Black / White Polycarbonate Base with ready fixed gasket and High Output square screw on Clear Prismatic diffuser.
 Includes 2D Lamp.

Lamps	Square x	Base Depth (mm)	Ref No. Colour	Order No. 0001
-------	----------	-----------------	----------------	----------------

Switch Start Midi

28W 2D	260 x 90	Black	SQ28BP	143801
28W 2D	260 x 90	White	SQ28WP	143827

Emergency High Frequency Midi

28W 2D 4 Pin	260 x 90	Black	SQ28BPHF/E3	143843
28W 2D 4 Pin	260 x 90	White	SQ28WPHF/E3	143869

Photocell Option

Internal Mounted Easy Wire Photocell			SCQ1/PCELL	143872
--------------------------------------	--	--	------------	--------

Lamps	Dia. x Depth (mm)	Base Colour	Ref No.	Order No. 0001
-------	-------------------	-------------	---------	----------------

Switch Start Mini

16W 2D 2 Pin	230 x 98	Black	SC16BP	143607
16W 2D 2 Pin	230 x 98	White	SC16WP	143623

Switch Start Midi

28W 2D 2 Pin	300 x 98	Black	SC28BP	143649
28W 2D 2 Pin	300 x 98	White	SC28WP	143665
38W 2D 4 Pin	300 x 98	Black	SC38BP	143762
38W 2D 4 Pin	300 x 98	White	SC38WP	143788

High Frequency Midi

28W 2D 4 Pin	300 x 98	Black	SC28BPHF	143681
28W 2D 4 Pin	300 x 98	White	SC28WPHF	143704

Emergency High Frequency Midi

28W 2D 4 Pin	300 x 98	Black	SC28BPHF/E3	143720
28W 2D 4 Pin	300 x 98	White	SC28WPHF/E3	143746

Photocell Option

Internal Mounted Easy Wire Photocell			SCQ1/PCELL	143872
--------------------------------------	--	--	------------	--------

Switch Start Maxi

38W 2D 4 Pin	360 x 100	Black	SCM38LEP	129061
38W 2D 4 Pin	360 x 100	White	SCM38LEPW	129087

Emergency High Frequency Maxi

38W 2D 4 Pin	360 x 100	Black	SCM38HFLEP/E3	129184
38W 2D 4 Pin	360 x 100	White	SCM38HFLEPW/E3	129207



Lighting

RECTANGULAR BULKHEAD



SECTOR



CITADEL
Powering industry since 1977

IP65 Rectangular Bulkheads

Simple compact bulkheads for inside or out with many lamp and base / diffuser options.

All bases have many entry points and gaskets between screw on diffusers.

GLS version requires lamps.

Low Energy includes 9W PLS 2 Pin CFL lamps.

Lamps	Base	Diffuser	Ref No.	Order No. 0001
-------	------	----------	---------	----------------

GLS / BC CFL

100W BC	Metal	Glass	S1001MG	119479
100W BC	Poly	Poly	SBHP100	119505
100W BC	Metal	Poly	S1001MP	119453
100W BC, Red Lens	Metal	Poly	S1001MPR	119466
60W BC, PIR (IP54)	Poly	Poly	SP1R110BH	134098
60W BC, PEC (IP54)	Poly	Poly	SPCELLBH	145867

Low Energy

1 x 9WTCS	Poly	Poly	SBHP19	124493
2 x 9WTCS	Poly	Poly	SBHP29	124503
2 x 9WTCS	Metal	Poly	S1001LE	119482
1 x 9WTCS, Photocell	Poly	Poly	SBHP19/PC	124516
2 x 9WTCS, Photocell	Poly	Poly	SBHP29/PC	124529

Bulkhead Corner mounting Bracket			SBH1/CB	126695
----------------------------------	--	--	---------	--------

Robolite IP65 Metal Bulkhead

IP65 Heavy Duty vandal resistant Die Cast Base.

Opal polycarbonate diffuser secured to gasket on base via tamperproof screws.

White base, Opal diffuser. Includes 8WT5 fluorescent tube.

Description	Ref No.	Order No. 8274
8WT5	EL-JGR8/230	894895
8WT5, Maintained	EL-JGR8/3M	114818
8WT5, Non-Maintained	EL-JGR8/3NM	114821
Robolite Self Adhesive Multi Legend	EL-16ML/JG	114753

SECTOR

IP44 Caged Bulkhead

IP44 Polycarbonate base and glass lens with steel wire cage.

Dimensions: (L)250mm x (W)140mm.

Requires Lamps.

Lamps	Base	Diffuser	Ref No.	Order No. 0001
60W ES	Black	Glass	SBLB	111545
60W ES	White	Glass	SBLW	111558

Lighting

BULKHEADS & BRICKLIGHTS



SECTOR

IP65 Oval Bulkhead

All polycarbonate with smart smooth edges ideal for commercial and residential applications.

Dimensions: (W)270mm x (H)110mm.

Requires Lamps.

Lamps	Base	Diffuser	Ref No.	Order No. 0001
60W ES	Black	Poly	SOVB	111529
60W ES	White	Poly	SOVW	111532

SECTOR

IP44 Louvered Eyelid Bulkhead

IP44 sturdy cast aluminium and glass construction.

Dimensions: (L)190mm x (W)140mm.

Requires Lamps.

Lamps	Base	Diffuser	Ref No.	Order No. 0001
60W ES	Black	Glass	SWL60EYE	125379

SECTOR

IP44 Recessed Brick light

IP44 die cast construction supplied with a choice of plain and louvered bezel to cover opal glass diffuser.

Dimensions: (W)215mm x (H)75mm x (D)70mm.

Requires Lamps.

Lamps	Base	Diffuser	Ref No.	Order No. 0001
GLS / ES CFL				
40W ES	Black	Opal	SBKL40WES	125078
40W ES	White	Opal	SBKL40WES	125065

Low Energy

1 x 9WTCS	Black	Opal	SBKL9WPL	125094
1 x 9WTCS	White	Opal	SBKL9WPL	125081



SECTOR *plus*

Lighting

EXTERIOR WALL PACKS & DISCHARGE FLOODLIGHTS



AM-COMBH282D



S7070I



S70SONI



EX-COMPOLY70S

EXTERIOR WALL PACKS



IP65 Compoly Slim Wall Pack

A Slim Innovative discharge Bulkhead in tough Black polycarbonate and prismatic diffuser with eyelid feature to inhibit upward light pollution.

Includes lamps.

Lamps	Type	Cap	Ref No.	Order No.
				5544

Fluorescent

28W	2D	2 Pin	AM-COMBH282D	023629
-----	----	-------	--------------	--------

High Pressure Sodium

70W	Son	ES	AM-COMBH70S	023742
70W, Photocell	Son	ES	AM-COMBH70S/PC	023755



IP65 Starlux High Output Wall Pack

An extremely robust IP65 Polycarbonate bulkhead.

For ease of maintenance, control gear is mounted integrally on a removable tray.

Includes lamps.

Lamps	Type	Cap	Ref No.	Order No.
				0001

High Pressure Sodium

70W	Son	ES	S7070I	125887
70W, Photocell	Son	ES	S7070I/PC	125890

Quartz Metal Halide

70W	Halide	ES	S7070H	138887
70W, Photocell	Halide	ES	S7070H/PC	138874

High Frequency Fluorescent

42W	TCTE	4 Pin	S7042HF	135437
42W, Photocell	TCTE	4 Pin	S7042HF/PC	135440

EXTERIOR DISCHARGE FLOODLIGHTS



IP65 General Purpose Discharge Floodlights

Impact resistant anti corrosive polycarbonate body and front cover. Symmetrically positioned lamp and reflector.

White light halide version available and photocell option.

Includes lamps.

Lamps	Type	Cap	Ref No.	Order No.
				0001

High Pressure Sodium

70W	Son	ES	S70SONI	110083
70W, Photocell	Son	ES	S70SONI/PC	124817

Quartz Metal Halide

100W	Halide	ES	S100MBI	124820
100W, Photocell	Halide	ES	S100MBI/PC	124833



IP65 Compact Polycarbonate Discharge Floodlights

Tough general purpose floodlight with high impact Polycarbonate base and lens.

UK manufactured and designed with performance symmetrical reflector and optics.

Dimension: (W)262mm x (H)375mm x (D)145 mm.

Includes lamps.

Lamps	Type	Cap	Ref No.	Order No.
				5544

High Pressure Sodium

70W	Son	ES	EX-COMPOLY70S	019992
70W, Photocell	Son	ES	EX-COMPOLY70S/ PC	020004

Quartz Metal Halide

70W	Halide	ES	EX-COMPOLY70H	020017
70W, Photocell	Halide	ES	EX-COMPOLY70H/ PC	020033



Lighting

EXTERIOR DISCHARGE FLOODLIGHTS



EX-COMFL70S



EX-ULFL150S



SFL70AMH

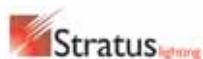

IP65 Compact Ultra Professional Discharge Floodlights

Modern aesthetic design to match the Stratus Ultra flood.
Tough general purpose floodlight with slim high impact Polycarbonate base with removable geartray system.
Tempered 4mm flat glass lens secured within polycarbonate frame by stainless steel screws.
UK manufactured and designed with high performance reflector and optics.
Many more lamp, gear, body and reflector options available.
Dimension: (W)262mm (H)375mm (D)125 mm.
Includes lamps.

Lamps	Type	Cap	Reflector	Ref No.	Order No.
					5544

High Pressure Sodium

70W	Son	ES	Symmetrical	EX-COMFL70S	011673
-----	-----	----	-------------	-------------	--------

Quartz Metal Halide

70W	Halide	TD	Symmetrical	EX-COMFL70H	011217
150W	Halide	TD	Symmetrical	EX-COMFL150H	011220
150W	Halide	TD	Asymmetrical	EX-COMAS150H	011288



IP65 Halide Miniflood

High quality silver powder coated cast aluminium construction.
Double ended metal halide lamps included for crisp white light.
Compact fitting with attractive slim profile and asymmetrical reflector.
Dimension W= 230mm, H= 350mm, D= 84mm.
Includes lamps.

Lamps	Type	Cap	Ref No.	Order No.
				0001

High Pressure Sodium

70W	Halide HQ1-TS	RX7	SFL70AMH	144910
150W	Halide HQ1-TS	RX7	SFL150AMH	144923



IP67 Ultra Professional Discharge Floodlights

Modern aesthetic design to match the Stratus Compact Ultra Professional flood.
IP67 suitable to operate in extreme environments and all weather conditions.
Tough general purpose floodlight with slim high impact Polycarbonate base with removable geartray system.
Tempered 4mm flat glass lens secured within polycarbonate frame by stainless steel screws.
UK manufactured and designed with an outstanding performance reflector and optics up to 30% more efficient than standard floodlights.
Many more lamp, gear, body and reflector options available.
Dimension: (W)433mm x (H)560mm x (D)165 mm.
Includes lamps.

Lamps	Type	Cap	Ref No.	Order No.
				5544

High Pressure Sodium

150W	Son	GES	EX-ULFL150S	011369
250W	Son	GES	EX-ULFL250S	011372
400W	Son	GES	EX-ULFL400S	011385

Quartz Metal Halide

250W	Halide	GES	EX-ULFL250H	011408
400W	Halide	GES	EX-ULFL400H	011686

For columns and brackets suitable for post top mounting see Page 67



Lighting

EXTERIOR DISCHARGE FLOODLIGHTS, URBAN & EXTERIOR DISPLAY LIGHTING



SFL150SON



EX-SFB2/76

SECTOR



IP66 Die Cast Discharge Floodlights

A powerful symmetrical general purpose floodlight with a compact and unobtrusive die cast aluminium construction and toughened glass cover providing good photometric performance.

Available with pre-installed photocells factory fitted into body.

Dimension: (W)360mm (H)460mm (D)132 mm.

Includes lamps.

Lamps	Type	Cap	Ref No.	Order No. 0001
-------	------	-----	---------	-------------------

High Pressure Sodium

150W	Son	GES	SFL150SON	136135
250W	Son	GES	SFL250SON	124338
250W, Photocell	Son	GES	SFL250SON/PC	124765
400W	Son	GES	SFL400SON	124341
400W, Photocell	Son	GES	SFL400SON/PC	124383

Quartz Metal Halide

250W	Halide	GES	SFL250MH	124354
250W, Photocell	Halide	GES	SFL250MH/PC	124396
400W	Halide	GES	SFL400MH	124367
400W, Photocell	Halide	GES	SFL400MH/PC	124406

URBAN & EXTERIOR DISPLAY LIGHTING



Steel Columns and Floodlight Brackets

Hot dipped galvanised tubular steel Industry standard lighting columns.

Bitumen coated root with lockable access door.

All columns listed have 76mm spigot tops to match the column top floodlight brackets.

Many more columns and bracketry available.

Delivered direct to site pre-booked 7-10 days in advance.

Description	Ref No.	Order No. 5544
-------------	---------	-------------------

Galvanised Columns

3M Root mounted Column	EX-TC3	027890
4M Root mounted Column	EX-TC4	027900
5M Root mounted Column	EX-TC5	027913
6M Root mounted Column	EX-TC6	027926
8M Root mounted Column	EX-TC8	027939

Column Tops

1 Way Floodlight Bracket	EX-SFB1/76	028200
2 Way Floodlight Bracket	EX-SFB2/76	028239
3 Way Floodlight Bracket	EX-SFB3/76	028268
4 Way Floodlight Bracket	EX-SFB4/76	028297

Column Accessories

ColumnTop Spigot Reducer 76mm - 60mm	EX-CTA76/60	028556
Fused Cut Out (Requires Fuse)	EX-FCO	028190

SECTOR *plus*

Lighting

URBAN & EXTERIOR DISPLAY LIGHTING



EX-LAN70S

SPEC4E(A/SRG)

SPEC20

SWELLGLS1

SWELLBRKT

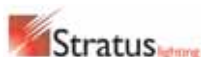

Road Lanterns

Street lighting luminaire designed with ease of installation and lamp change in mind.

Cast body and pressed steel cover with an IP65 optical assembly with glass cover and IP44 gear housing.

Option of factory fitted Neema photocell and socket.

60mm diameter side and base spigot entries.

Dimension: (L)510mm x (W)320mm x (D)250 mm. Weight 9.6kg.

Includes gear and High Pressure Sodium lamps.

Lamps	Type	Cap	Ref No.	Order No. 5544
70W	Son	ES	EX-LAN70S	012737
70W, Photocell	Son	ES	EX-LAN70S/PC	019277
150W	Son	GES	EX-LAN150S	012740
150W, Photocell	Son	GES	EX-LAN150S/PC	019280



NEMA Photocells

30 years reliability lighting Britain's streets and standard NEMA plug and socket connection.

Manufactured in the UK, CE marked and BS5972.

Switch 1000W resistive 600W inductive loads.

Intelligent part night version switches off during very early hours of the morning then on again just before dawn.

Description	Ref No.	Order No. 0001
-------------	---------	----------------

Head Only

Anti Surge NEMA Photocell	SPEC4E(A/SRG)	112764
---------------------------	---------------	--------

Kits

Anti Surge NEMA Photocell and Base	SPEC4EKIT	112777
Part Night NEMA Photocell and Base	SPEC9PN	135291



General Purpose Photocells

Manufactured in the UK, CE marked and BS5972.

Miniature mount in 20mm dia. aperture within fittings or in enclosures.

Varocell unit has easy wire terminals and 20mm grommet entry features include light level and time on/off adjustments.

Switch 1000W resistive 600W inductive loads.

Description	Ref No.	Order No. 0001
-------------	---------	----------------

Miniature

20mm Photocell	SPEC20	125861
20mm Photocell Head & Remote Unit	SPEC20/R	125874

Wall Mount

Varocell Time and Lux Adjustable Photocell	SVARO4	135288
--	--------	--------



Wellglass Luminaire

IP65, CE marked and BS4533.102.1.

Pre-wired two piece construction for simple and speedy installation.

Sturdy powder coated die-cast aluminium construction.

Can be wall or corner mounted with optional bracket.

GLS version requires lamp - See page 5. Low energy version includes lamp.

Lamp	Finish	Diffuser	Ref No.	Order No. 0001
------	--------	----------	---------	----------------

GLS / BC CFL

100W, BC	Black	Opal Glass	SWELLGLS1	991477
----------	-------	------------	-----------	--------

Low Energy

18W, TCD 2 Pin	Black	Opal Glass	SWELLCF1	991875
Corner Mount Bracket	Black		SWELLBRKT	000290



Lighting

EXTERIOR DISPLAY LIGHTING



SECTOR



Low Energy Flood / Sign Light

Slim linear design with efficient specular parabolic optic.
IP65 black polycarbonate body with stainless steel exterior fixings.
A compact area floodlight and when fitted with arm becomes a very effective and unobtrusive low energy sign light.
Includes lamps.

Lamp	Type	Cap	Length	Ref No.	Order No. 0001
26W	TCD	2 Pin	220mm	SIGNLOWEN26	112913
2x26W	TCD	2 Pin	460mm	SIGNLOWEN226	112926

Accessories

Accessories	Length	Ref No.	Order No. 0001
Sign light Arm & Besa Cover	400mm	SIGNLOWENARM	112939
Besa Wall Mount Kit		SIGNLOWENBESA	112942
Nylon Ground Spike	200mm	SIGNLOWENSPK	135301

SECTOR



Asymmetrical Mini Flood

IP65 Tiny Discharge floodlight with Innovative design.
Asymmetrical beam distribution ideal for general floodlighting where an enhanced degree of light control is needed helping to prevent light pollution.
Polycarbonate body bracket and lens, Includes lamps.

Lamp	Type	Cap	Ref No.	Order No. 0001
------	------	-----	---------	-------------------

Discharge

70W	Son	ES	SFL70A	138900
70W, Photocell	Son	ES	SFL70A/PC	138890

High Frequency Fluorescent

42W	TCTE 4 Pin		SFL42A	138913
42W, Photocell	TCTE 4 Pin		SFL42A/PC	138926

SECTOR

IP65 Low Voltage Spot / Sign light

Sturdy die cast aluminium construction.
Rear side and top conduit entry points.
Includes 50VA toroidal transformer.
Requires lamp.

Lamp	Type	Finish	Length	Ref No.	Order No. 0001
------	------	--------	--------	---------	-------------------

Spotlight

50W	12V 50mm	Black	240mm	SLVSURF65 BLK	132317
50W	12V 50mm	White	240mm	SLVSURF65 WHI	132320
Ground Spike		St/Steel	300mm	SLVSPK290	135314

Signlight

50W	12V 50mm	Black	900mm	SIGNLV900 BLK	132304
-----	----------	-------	-------	---------------	--------

SECTOR

Cowl Sign Light

A traditional Cowl sign light of Solid brass or polished chrome construction to ensure its quality looks last.
Requires lamp.

Lamp	Type	Finish	Length	Ref No.	Order No. 0001
------	------	--------	--------	---------	-------------------

GLS / ES CFL

100W	ES	Brass	500mm	SIGNCOWL BRS	112955
100W	ES	Chrome	500mm	SIGNCOWL CHR	132294

SECTOR Plus

Lighting

HALOGEN FLOODLIGHTING



HALOGEN FLOODLIGHTS



Wall Mounted Halogen Floodlights

IP55 Die cast aluminium base with heat resisting glass lens and bright stippled reflector.

Complete with mounting stirrup.

Includes lamp.

Description	Type	Finish	Ref No.	Order No. 0001
-------------	------	--------	---------	----------------

Mini Flood

150W	DE Halogen	Black	S150TEFB	134357
150W	DE Halogen	White	S150TEFW	134344

Midi Flood

500W	DE Halogen	Black	S500TEB	134331
500W	DE Halogen	White	S500TEW	134328

Mounting Brackets

Corner Bracket, 90°	Black	S500/CB	126679	
Swivel Bracket, 180°	Black	S500/SB	126682	



Professional Halogen Floodlights

CE marked, IP55 and BS4533.

Professional grade die cast aluminium with stainless steel quick release clasps ensuring easy lamp change when opening corrosion free frame.

750W to 1500W adjustable lamp holder included in Maxi.

Heat resisting glass lens and bright stippled reflector.

Includes 500W or 1000W lamp.

Lamp	Type	Finish	Ref No.	Order No. 0001
------	------	--------	---------	----------------

Midi Pro Flood

500W	DE Halogen	Black	S500TEPRO	124600
------	------------	-------	-----------	--------

Maxi Pro Flood

1000W	DE Halogen	Black	S1500TEPRO	124590
-------	------------	-------	------------	--------

For full range of passive infra red detectors and controls see Pages 98, 99



Lighting

HALOGEN & LOW ENERGY FLOODLIGHTING



SECTOR

PIR Halogen Floodlights

IP55 Die cast aluminium base with heat resisting glass lens and bright stippled reflector.

Complete with mounting stirrup.

Detection range 12m x 110°, duration 20 sec- 10 mins.

Dual override and lux level adjustment.

Includes lamp.

Description	Ref No.	Order No. 0001
150W Floodlight / PIR Combination 110° (Black)	S0015B	134056
150W Floodlight / PIR Combination 110° (White)	S0015W	134069
500W Floodlight / PIR Combination 110° (Black)	S009B	990342
500W Floodlight / PIR Combination 110° (White)	S009W	134072

SECTOR

PIR Halogen Floodlights

Detection range: 15m.

Switching capacity: 1000W incandescent.

Thermal accommodation feature for optimal PIR performance all year round.

Description	Ref No.	Order No. 0001
500W Professional Floodlight / PIR Combination 140° (Black)	SPIR140FLD	134124
500W Professional Floodlight / PIR Combination 200° (Black)	SPIR200FLD	134137

SECTOR

Low Energy Floodlight/PIR/PEC Combinations



Building Regs Part L1 compliant, IP44, Polycarbonate construction.

Adjustable floodlight for increased beam control.

Up to 80% cheaper running cost than GLS equivalent.

Includes lamps & high frequency control gear.

Description	Ref No.	Order No. 0001
2 x 26WTCTE 4 Pin	SLEF226	147179
2 x 26W c/w PIR	SLEF226PIR	147182
2 x 26W c/w Photocell	SLEF226PEC	147195

Lighting LANTERNS



DECORATIVE LANTERNS



Aluminium Coach Lanterns

IP44 cast aluminium construction with 6 clear glass panels.

PIR version has a detection range of 8m x 110° and a hard-wired override facility.

Requires lamps.

Description	Ref No.	Order No. 0001
60W Aluminium Lantern (Black)	SAL6CLB	134166
60W Aluminium Lantern with PIR (Black)	SAL6CLPIRB	134140
60W Aluminium Lantern with PIR (White)	SAL6CLPIRW	134153
60W Aluminium Lantern (White)	SAL6CLW	134179



Aluminium Half Lanterns

IP44 cast aluminium construction with 5 clear glass panels.

PIR version has a detection range of 8m x 110° and a hard-wired override facility.

Requires lamps.

Description	Ref No.	Order No. 0001
60W Aluminium Half Lantern (Black)	SAL5HLB	134205
60W Aluminium Half Lantern with PIR (Black)	SAL5HLPIRB	134182
60W Aluminium Half Lantern with PIR (White)	SAL5HLPIRW	134195
60W Aluminium Half Lantern (White)	SAL5HLW	134218



Polycarbonate Half Lanterns

IP44 vandal resistant polycarbonate body and 1 piece lens.

Pre-wired and quick fit installer connection.

Additional low energy versions and two alternative switching options.

PIR version has a detection range of 6m x 110° with a manual override and walk test facility.

Height 380mm.

GLS Version requires lamps.

Energy saving version Includes a 9W PLS lamp and complies to Part L1 of the building regs.



Lamp	Type	Finish	Ref No.	Order No. 0001
------	------	--------	---------	----------------

Half Lantern

60W	ES	Black	SHL	995651
60W	ES	White	SHLW	996922

Half Lantern with PIR

60W	ES	Black	SHLPIR	995664
60W	ES	White	SHLPIRW	996935

Half Lantern with Photocell

60W	ES	Black	SHLPC	129773
60W	ES	White	SHLPCW	129786

Low Energy with Photocell

9W	TCS 2 Pin	Black	SHL9PLPC	124435
9W	TCS 2 Pin	White	SHL9PLPCW	124448



Lighting LANTERNS

SHL



SHLW



SCLPIRW



SECTOR



Polycarbonate Coach Lanterns

IP44 vandal resistant polycarbonate body and 1 piece lens.

Prewired and quick fit installer connection.

Additional low energy versions and two alternative switching options.

PIR version has a detection range of 6m x 110° with a manual override and walk test facility.

Height 380mm (550mm Maxi).

GLS Version requires lamps.

Energy saving version includes a 9W PLS (26W PLC Maxi) lamp and complies to Part L1 of the building regs.

Lamp	Type	Finish	Ref No.	Order No. 0001
------	------	--------	---------	----------------

Coach Lantern

100W	BC	Black	SCL	995486
100W	BC	White	SCLW	996883

Coach Lantern with PIR

100W	BC	Black	SCLPIR	995622
100W	BC	White	SCLPIRW	996896

Coach Lantern with Photocell

100W	BC	Black	SCLPC	991037
100W	BC	White	SCLPCW	110384

Low Energy Coach Lantern

100W	BC	Black	SCL9PL	991147
100W	BC	White	SCL9PLW	115376

Low Energy with Photocell

9W	TCS 2 Pin	Black	SCL9PLPC	124419
9W	TCS 2 Pin	White	SCL9PLPCW	124422

Coach / Globe Accessories

Corner Bracket	Black	SCGCB	124477
Corner Bracket	White	SCGCBW	124480

Lamp	Type	Finish	Ref No.	Order No. 0001
------	------	--------	---------	----------------

Maxi Coach Lantern

150W	BC	Black	SCLM150B	145236
150W	BC	White	SCLM150W	145249

Maxi Coach Lantern with Photocell

150W	BC	Black	SCLM150PC B	145252
150W	BC	White	SCLM150PC W	145265

Low Energy Maxi Coach Lantern

26W	TCT 2 Pin	Black	SCLM26B	145278
26W	TCT 2 Pin	White	SCLM26W	145281

Low Energy Maxi Coach Lantern with Photocell

26W	TCT 2 Pin	Black	SCLM26PC B	145294
26W	TCT 2 Pin	White	SCLM26PC W	145304



SECTOR Plus

Lighting

LANTERNS & BOLLARDS



SGL

SCLPOST

SCLPED

SECTOR

Polycarbonate Globe Lanterns

An attractive globe lantern with Many of the features of the Polycarb coach and half lantern.

Height 380mm.

Requires lamps.

Lamp	Type	Finish	Ref No.	Order No. 0001
------	------	--------	---------	----------------

Globe Lantern

100W	BC	Black	SGL	995635
100W	BC	White	SGLW	996906

Globe Lantern with PIR

100W	BC	Black	SGLPIR	995648
100W	BC	White	SGLPIRW	996919

SECTOR

Polycarbonate Pedestal and Post

Attractive Posts similar in style to the polycarbonate coach lanterns.

Requires lamps.

Lamp	Height	Type	Finish	Ref No.	Order No. 0001
------	--------	------	--------	---------	----------------

Coach Pedestal

100W	480mm	BC	Black	SCLPED	991299
100W	480mm	BC	White	SCLPEDW	115389

Coach Post

100W	844mm	BC	Black	SCLPOST	124451
------	-------	----	-------	---------	--------

Lighting

LANTERNS & BOLLARDS



SECTOR

Sheffield Stainless Steel Classic Wall Lights

IP44 High grade stainless steel with glass diffuser.

GU10 up / downlight includes lamps.

GLS / ES CFL version requires lamps.

Lamp	Height	Type	Finish	Ref No.	Order No. 0001
------	--------	------	--------	---------	----------------

Classic Lantern

60W	310mm	ES	St/Stl	SHEF2CL	135806
-----	-------	----	--------	---------	--------

Up / Downlight

2 x 35W	170mm	GU10	St/Stl	SHEF2GU35	140820
---------	-------	------	--------	-----------	--------

SECTOR

Sheffield Stainless Steel Amenity Lights

IP44 High grade stainless steel on a curved slim luminaire.

260mm Height 235mm Width PIR range = 10m.

Requires lamp 60W ES max or low energy ES CFL.

Description	Type	Finish	Ref No.	Order No. 0001
60W	ES	St/Stl	SHEF2W	135819
60W, PIR	ES	St/Stl	SHEF2W/PIR	135822

SECTOR

Sheffield Stainless Steel Tubular Lighting

IP44 high grade stainless steel for a very modern contemporary luminaire.

Require low energy screw cap CFL lamps 20W max 160mm long.

Lamp	Height	Cap	Finish	Ref No.	Order No. 0001
------	--------	-----	--------	---------	----------------

Posts

20W	435mm	ES CFL	St/Stl	SHEF2P04	135783
20W	800mm	ES CFL	St/Stl	SHEF2P1	135796

Wall Light

20W	400mm	ES CFL	St/Stl	SHEF2PW	135770
-----	-------	--------	--------	---------	--------

Lighting

LANTERNS & BOLLARDS



Marine Style Lantern and Posts

Classic marine style lanterns and posts constructed of polycarbonate with glass diffuser.

Requires lamp 60W ES max or low energy ES CFL.

Lamp	Height	Cap	Type	Ref No.	Order No. 0001
Floor Mount					
60W	305mm	ES	Pedestal	SMARPED	112861
60W	940mm	ES	Post	SMARPOST	112845
Wall Mount					
60W		ES	Lantern	SMARWALL	112858



Polycarbonate Bollard

High quality PVC column and Polycarbonate opal lens and head.

Root mounted with optional first fix kit for easier installation.

Unique domed head 260mm diameter providing a wide spread of light with little skyward lightspill.

IP65 1M tall supplied with lamps (except GLS version).

Flange mounted surface version available.

Lamp	Type	Cap	Ref No.	Order No. 0001
150W / 23W	GLS/L/E	ES	SBL150ES	146604
70W	SON E	ES	SBL70SON	146617
70W	HALIDE	ES	SBL70MH	146620
42W	TCTE	4 Pin	SBL42HF	146633
42W	TCTE	4 Pin	SBL42HF/PC	146646
42W	TCTE	4 Pin	SBL42HF/E3	146659
ROOT MOUNTING KIT			SBL1ROOT	146662



Aluminium Bollard

Clean modern styled aluminium bollard with polycarbonate diffuser built to IP54.

Black textured exterior with internal white aluminium louvre.

1350mm Rooted with substantial 160mm diameter.

Discharge fittings include lamps.

Low Energy Bollard requires lamp.

Lamp	Cap	Finish	Ref No.	Order No. 5544
------	-----	--------	---------	----------------

Low Energy

42W	TCTE	4 Pin	AM-BOL42HF	023409
-----	------	-------	------------	--------

Discharge

50W	MBFU	ES	AM-BOL50M	012436
70W	Son	ES	AM-BOL70S	012423
70W	Halide	ES	AM-BOL70H	023205

Lighting

EXTERIOR DISPLAY LIGHTING



EXTERIOR DISPLAY LIGHTING

SECTOR IP44 Par38 Wall and Garden Spotlights

Tough Polyester weather & corrosion resistant fitting with rubber gasket attached to fitting.
Pre-wired with 2m of rubber cable.
Requires Par 38 Hard glass lamp for exterior use.

Lamp	Height	Type	Heads	Ref No.	Order No. 0001
------	--------	------	-------	---------	----------------

Wall Mount					
120W	Par 38	ES	Single	SP38WB1	136410

Ground Spike					
120W	Par 38	ES	Single	SP38GS1	136397
120W	Par 38	ES	Twin	SP38GS2	136407

SECTOR

Low Energy Flood

A powerful IP65 energy efficient and compact floodlight with mounting stirrup.
Addition of a ground spike for mounting within landscaped environments.
Includes Lamps.

Description	Type	Finish	Length	Ref No.	Order No. 0001
Floodlight 26W	TCD	2 Pin	220mm	SIGNLOWEN26	112913
Besa Wall Mount Kit				SIGNLOWENBESA	112942
Nylon Ground Spike			200mm	SIGNLOWENSPK	135301

Lighting

EXTERIOR LINKLITE SYSTEM



SL12VT60

SL12VS9LEDBLU

SL12VRL03

SL12VSSBOL

SL12VMB05

SL12VPL04

EXTERIOR LINKLITE SYSTEM

The sector range of garden and landscape lighting provides a unique method of designing, developing and expanding a domestic or commercial landscape lighting scheme

Complimentary luminaires to provide many different lighting effects:

Up and Down lighting, spotlighting, Silhouetting, pathway and marker lighting background and even underwater lighting.

With the safety of low voltage and flexibility to mix both LED and halogen light sources by linking them together ensures this is the ultimate in terms of flexibility and control even in commercial applications.

SECTOR

LinkLite Transformers & Cable

Wire wound weather resistant transformers suitable for driving Low voltage and low wattage LED lamps.

IP44 rated so need to be protected in a higher rated enclosure if mounted in exposed or continually wet environments.

Supplied pre-wired with plug and LinkLite connector.

Cable is 2mm twin coiled in convenient lengths.

Soft rubber sheath ensures protection and ability for low voltage connectors on fittings to penetrate without complicated wiring.

Lamp	Volts	Size	Ref No.	Order No. 0001
------	-------	------	---------	----------------

LinkLite Transformers

1 - 60VA	12V	93 x 65 x 70mm	SL12VT60	132236
1 - 150VA	12V	126 x 82 x 82mm	SL12VT150	132249

Description	Colour	Size	Ref No.	Order No. 0001
-------------	--------	------	---------	----------------

LinkLite Cables

Cable	Black	25M	SL12VC25	132252
Cable	Black	50M	SL12VC50	132265

LinkLite Accessories

Spare LinkLite Connector	SL12VCON	132278
IP44 Dusk Dawn Timer	SL12VDDT	146044
0-65W IP20 Universal LED Driver	SL12VT65LED	146808

SECTOR

LinkLite Posts & Rock Lights

Posts:

IP44 Black Die cast aluminium construction.

Includes 20W lamp, 2m cable and 12V LinkLite connector.

Suitable for use with LV Luxeon and cluster LEDs.

Posts:

IP44 poly resin construction with glass lens and screw down bezel.

Lamp	Volts	Height	Ref No.	Order No. 0001
------	-------	--------	---------	----------------

Mini Bollard

20W	12V 50mm	350mm	SL12VMB05	132197
-----	----------	-------	-----------	--------

Louvered Pagoda

20W	12V 50mm	550mm	SL12VPL04	132184
-----	----------	-------	-----------	--------

Stainless Steel Bollard

20W M47	12V G4	1000mm	SL12VSSBOL	146057
---------	--------	--------	------------	--------

Rock Light

20W	12V 50mm	125mm	SL12VRL03	132171
-----	----------	-------	-----------	--------

SECTOR

LinkLite IP68 Utility Light

Smart IP68 submersible stainless steel fitting with wall or floor mounting plate and optional ground spike.

12 cluster LED array in white or blue with upto 50,000 hrs life.

Includes 5M cable and Linklite connector.

Lamp	Type	Colour	Height	Ref No.	Order No. 0001
------	------	--------	--------	---------	----------------

1W 12V	12 x LED	White	100mm	SL12VS9LED WHI	142381
1W 12V	12 x LED	Blue	100mm	SL12VS9LED BLU	142394

Lighting

EXTERIOR LINKLITE SYSTEM



SECTOR

LinkLite Spotlights

Black die cast aluminium or stainless steel construction with glass lens and angular adjustment.

Includes 20W open Dichroic lamp, 2m cable and 12V LinkLite connector.

Suitable for use with LV cluster LEDs - See page 9.

Lamp	Volts	Height	Finish	Ref No.	Order No.
					0001

IP44 Spike Spotlight

20W	12V	50mm	300mm	Black	SL12VSL01	132155
20W	12V	50mm	200mm	St/Steel	SL12VSSPT	146073

IP68 Underwater Spotlight

20W	12V	50mm	150mm	Black	SL12VUL02	132168
35W	12V	50mm	150mm	St/Steel	SL12VSSUL	142378

SECTOR

LinkLite Surface Marker Lights

IP44 Black Die cast aluminium construction with glass lens and screw louvre / eyelid.

Includes 20W G4 M47 capsule lamp, 2m cable and 12V LinkLite connector.

Lamp	Type	Dia.	Finish	Ref No.	Order No.
					0001

Eyelid

20W M47	12V G4	100mm	Black	SL12VML07	132210
20W M47	12V G4	100mm	St/Steel	SL12VSSML	146060

SECTOR

IP67 Walkover LinkLite

A very high quality machined satin chrome single 1W Luxeon LED and driver featuring the latest technology to enable operation on the LinkLite LV system.

LED lamp life in excess of 50,000 hours.

A high quality machined satin chrome low voltage ground light with 20W lamp and suitable for use with LV Luxeon and cluster LEDs.

Lamp	Type	Colour	Cut Out x Depth	Ref No.	Order No.
					0001

LED Walkover

1W 12V	1x Luxeon	Blue	38 x 100mm	SL12VLUXGL BLU	135945
1W 12V	1x Luxeon	White	38 x 100mm	SL12VLUXGL WHI	135932

Walkover

20W	12V 50mm		72 x 110mm	SL12V50GL SCH	134690
-----	----------	--	------------	---------------	--------

SECTOR

IP67 Recessed Marker Lights

Compact and powerful LEDs provide stunning effects, housed in a small stainless steel housing.

Includes LED and 2m cable, 12V LinkLite connector and regulator.

LED lamp life in excess of 50,000 hours.

Lamp	Type	Colour	Cut Out x Depth	Ref No.	Order No.
					0001

LED Walkover

1W 12V	4 x LED	Blue	36mm x 30mm	SL12V4LED BLU	134713
1W 12V	4 x LED	White	36mm x 30mm	SL12V4LED WHI	134700
1W 12V	1 x HP LED	Blue	36mm x 30mm	SL12V1HP BLU	146785
1W 12V	1 x HP LED	White	36mm x 30mm	SL12V1HP WHI	146798

Lighting

EXTERIOR GROUNDLIGHT UPLIGHTERS



EXTERIOR GROUNDLIGHT UPLIGHTERS

SECTOR



IP67 240V Ground Light Driveover LED Uplighters

A top quality drive over with a 21 superbright LED lamp life in excess of 50,000 hours.

Quality satin chrome bezel and cast mounting sleeve, pre wired for 240V.

Low Energy consumption only 7W.

Lamp	Type	Colour	Cut Out x Depth (mm)	Ref No.	Order No. 0001
LED Driveover					
240V	21x LED	Blue	150 x 150	SGR21BLED	132281
240V	21x LED	White	150 x 150	SGR21WLED	125340

SECTOR

GLS/ES CFL Ground Light Driveover Uplighters

A basic walkover suitable for light drive over traffic.

Requires GLS ES lamp or low ES low energy max length 120mm.

Lamp	Type	Cut Out x Depth (mm)	Ref No.	Order No. 0001
GLS / ES CFL Walkover				
40W	ES	160 x 270	SGR40WES	125353

Stratus lighting



Sandringham IP67 Ground Light Uplighters

High quality in ground luminaire for professional and commercial use.

Ideal for pedestrian and light drive over areas.

Toughened safety glass and polymer mounting sleeve.

Lamp is directional +or - 25° within housing for accent lighting.

Requires lamp G12 Cap.

Lamp	Type	Colour	Cut Out x Depth (mm)	Ref No.	Order No. 5544
70W	Halide	G12	230 x 300	AM-SA70	012135
150W	Halide	G12	230 x 300	AM-SA150	012148

SECTOR

GU10 Ground Light Walkover Uplighters

A high quality cast satin chrome GU10 240V ground light with mounting sleeve.

Suitable for use with 240V Luxeon and Cluster LEDs - See page 10.

Requires lamp GU10 Base.

Due to build up of heat in enclosed fittings 20W max halogen is recommended or low energy GU10 lamp.

Lamp	Type	Cut Out x Depth (mm)	Ref No.	Order No. 0001
GU10 Walkover				
GU10	20W / GU10 LED	95 x 130	SGRGU/GZ	135275

SECTOR plus